

# ENGINE & MACHINERY DIVISION

HHI-EMD

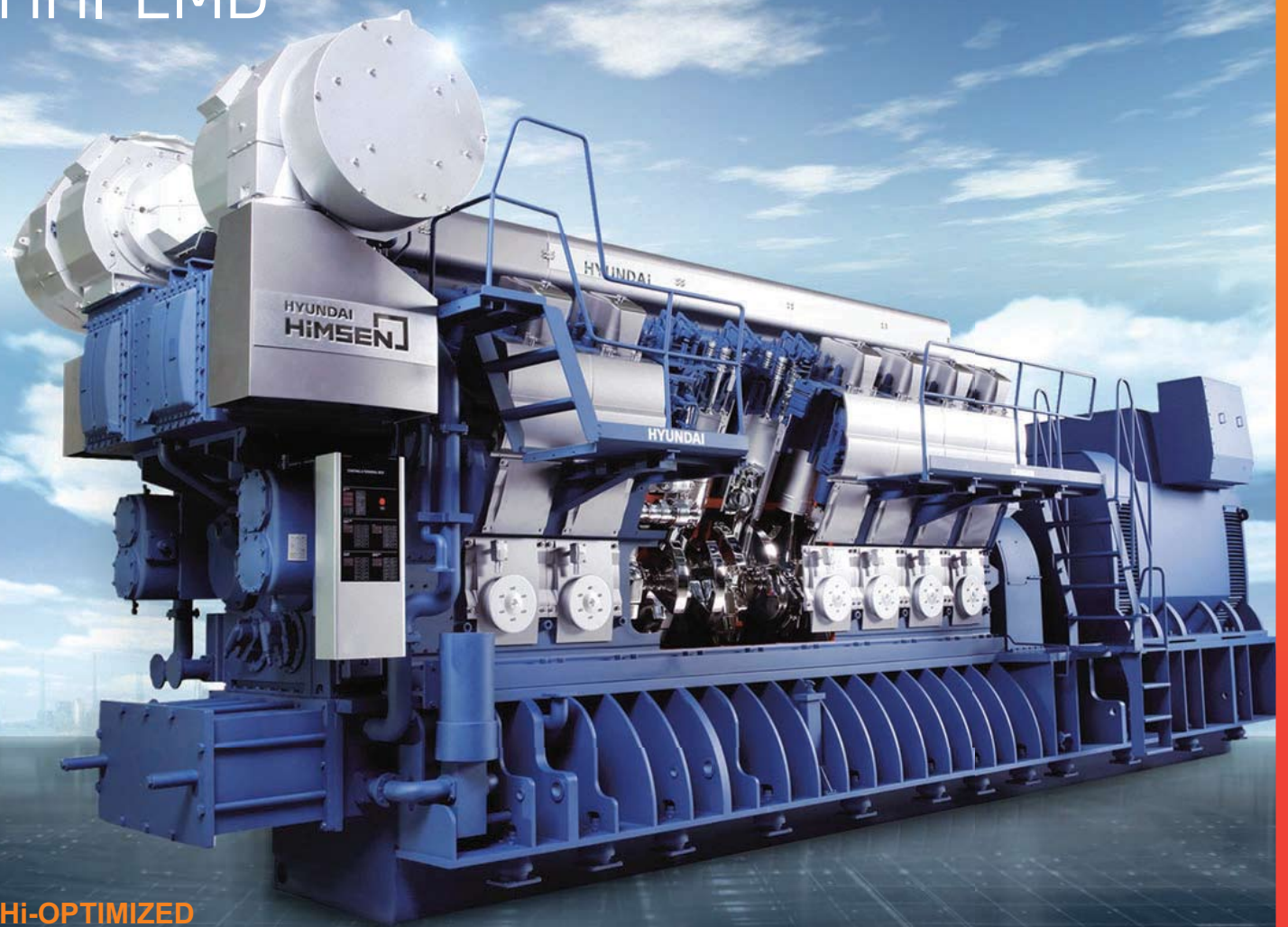

**Hi-OPTIMIZED  
POWER SOLUTIONS**

Power + Passion  
Smart + Optimization  
Eco + Sustainability



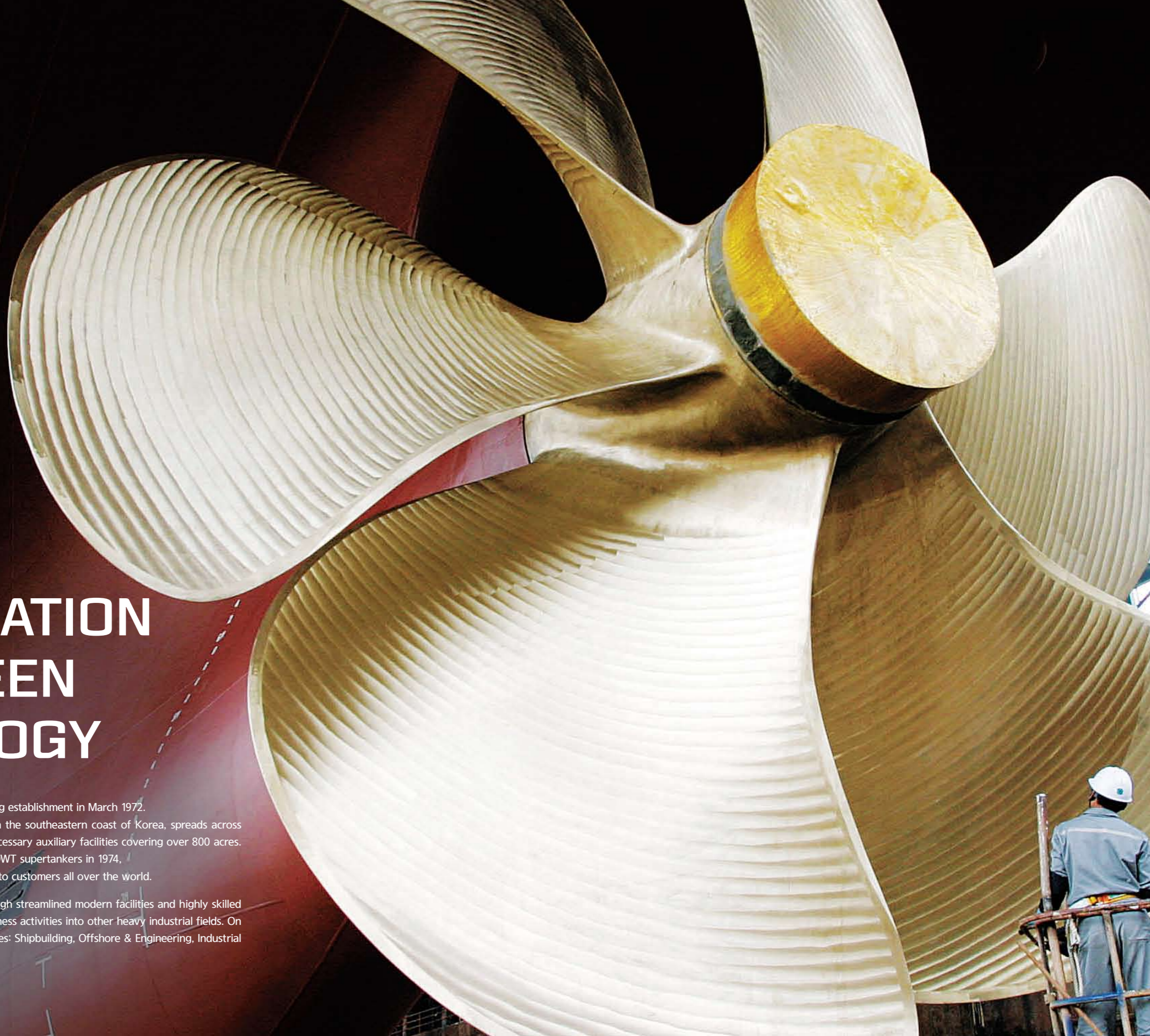

# THE GLOBALIZATION WITH GREEN TECHNOLOGY

Hyundai Heavy Industries (HHI) had its groundbreaking establishment in March 1972. HHI's main shipyard, located at Mipo Bay in Ulsan on the southeastern coast of Korea, spreads across 1,200 acres with its main production plants and all necessary auxiliary facilities covering over 800 acres. Since the successful delivery of its first two 260,000 DWT supertankers in 1974, HHI has built and delivered almost every kind of ship to customers all over the world.

Backed by technology and experience acquired through streamlined modern facilities and highly skilled manpower in shipbuilding, HHI has diversified its business activities into other heavy industrial fields. On this vast compound, HHI operates various business lines: Shipbuilding, Offshore & Engineering, Industrial Plant & Engineering and Engine & Machinery.



# Contents

## Introduction

- 05 History
- 06 HHI-EMD Zone
- 07 HHI-EMD'S GROWTH
- 07 Business Areas

## HHI-EMD PRODUCTS

### Marine Engine

- 10 2-Stroke Engine
- 12 4-Stroke HiMSEN Engine
- 14 HiMSEN Propulsion System

### Propeller & Shaft

- 18 Propeller & Shaft

### Component

- 20 Crankshaft
- 21 Turbocharger

### Marine Machinery

- 22 Hi-Well Cargo Pumping System
- 24 Hi-GAS
- 26 Hi-ERS
- 28 Hi-ReGAS
- 30 NoNOx
- 32 HiBallast Ballast Water Treatment System
- 34 EcoBallast Ballast Water Treatment System
- 36 HiEMS
- 37 HiCAS

### Engine Power Plant

- 38 Engine Power Plant
- 40 Packaged Power Station

## HHI-EMD PRODUCTION CAPABILITIES

### Production Facility

- 44 Foundry Shop
- 45 Machining Shop & Assembly-Test Shop

### Research & Development

- 46 Quality Management
- 47 Research & Development

### Customer Service

- 48 Hyundai Global Service
- 49 HiMSEN Global Academy

### Global Network

- 51 Contact Us

# History



- 1978** Completed the world's largest marine engine plant in the Hyundai shipyard
- 1979** Produced the first marine engine (HYUNDAI- B&W 7L55GF)
- 1984** Produced the first crankshaft for the 2-stroke engine
- 1985** Produced the first marine propeller
- 1999** Completed world's largest 200MW 2-stroke engine power plant in Chennai, India
- 2002** HiMSEN Engine was awarded as one of "Korea's Top 10 Best New Technologies of 2000"  
Succeeded TAT of HiMSEN H25/33
- 2006** Developed Hyundai hydraulically driven cargo oil pumping system  
Succeeded TAT of HiMSEN H32/40
- 2007** Established "Wartsila Hyundai Engine" for DF50 engines for LNG carriers  
Produced the world's most powerful 2-stroke diesel engine (Hyundai-Wartsila 14RT-flex96C, 108,920BHP)
- 2008** Developed high power HiMSEN Vee-Type (16H32/40V)  
Launched Hyundai's brand-new ballast water management system
- 2010** Achieved 2-stroke engine accumulated production with 100 million BHP  
Developed high output earth-friendly gas engine, H35G
- 2012** World's first test run of LNG package solution for LNG-fueled ship  
Produced 1,000th packaged power station
- 2014** Developed the re-liquefaction system Hi-ERS
- 2015** Achieved 2-stroke engine production with an aggregate output of 150 million BHP
- 2016** Produced the 10,000th HiMSEN engine for the 14,400-TEU containership  
The confirmation test for NoNOx LP SCR with 2-stroke Engine
- 2017** Produced the 5000th marine propeller



## HHI-EMD Zone

### MAIN OFFICE ZONE

1. Main Building & Annex

### ENGINE SHOP 1 ZONE

2. Crankshaft Shop 1
3. Machining Shop 1-1
4. Machining Shop 1-2
5. 4-Stroke Engine Ass'y & Test Shop 1
6. 2-Stroke Engine Ass'y & Test Shop 2-1
7. 2-Stroke Engine Ass'y & Test Shop 1-1
8. 2-Stroke Engine Ass'y & Test Shop 1-2
9. Propeller Shop 1
10. Foundary Shop

### ENGINE SHOP 2 ZONE

11. 2-Stroke Engine Ass'y & Test Shop 2-2
12. Machining Shop 2-1
13. Machinery Ass'y Shop

### ENGINE SHOP 3 ZONE

14. Crankshaft Shop 2
15. 4-Stroke Engine Ass'y & Test Shop 2
16. 2-Stroke Engine Ass'y & Test Shop 1-3

### YARD 2 ZONE

17. Machining Shop 1-3



## HHI-EMD's Growth

HHI's people are outstanding creators because:

- We have the passion to achieve the best
- We have innovative minds to change the world
- We endeavor to build trust based on honesty and integrity

As one of the leading engine builders in the world, HHI's Engine & Machinery Division (HHI-EMD) has enjoyed its reputation since its beginning in 1978. HHI-EMD has taken up 35% of the world's market share in engines for marine and stationary purposes. This shows that the superior quality of HYUNDAI engines is recognized by customers all over the world.

HHI-EMD has also developed its own engine brand HIMSEN, which is specially designed as part of the ongoing efforts to provide the most practical and highest quality engines to our customers.

Key advantages of the HiMSEN engine include reliability, durability, long service intervals, easy maintenance, cost efficiency in operation, and environmental friendliness. Based on its leading position in engine production, HHI-EMD has become the forerunner in the sector of engine power generation as well. A great number of its domestic and overseas engine power plants have given superb performance, contributing to the HYUNDAI's high reputation.

The business activities of HHI-EMD have been further expanded into diverse fields of marine machinery such as marine pumps & turbines, ballast water treatment system and LNG gas solutions.

## HHI-EMD Business Areas

### MARINE ENGINE & MARINE MACHINERY

#### 2-Stroke / 4-Stroke Engines

- Diesel engines
- Gas engines
- Dual fuel (DF) engines

#### Engine Components

- Crankshaft, cylinder liner etc.
- Turbochargers

#### Marine Eco Machinery

- Hi-Well cargo pumping systems
- Hi-GAS: Hyundai Integrated Gas Supply System
- Hi-ReGAS: Hyundai Integrated ReGASification System
- Hi-ERS: Hyundai Innovative Economical Re-liquefaction System

### Propellers & shafts / Propulsion

#### Propellers & shafts

- Propellers, shafts, rudder stocks

#### Marine Propulsion

- HiMSEN Propulsion System

### POWER PLANT

#### Stationary Engine Power Plants

- Heavy Fuel Oil (HFO)
- Diesel Oil (DO)
- GAS
- Dual Fuel

#### Packaged Power Stations

Emergency diesel generator (EDG) for nuclear power plants

#### Barge-Mounted Engine Power Plants

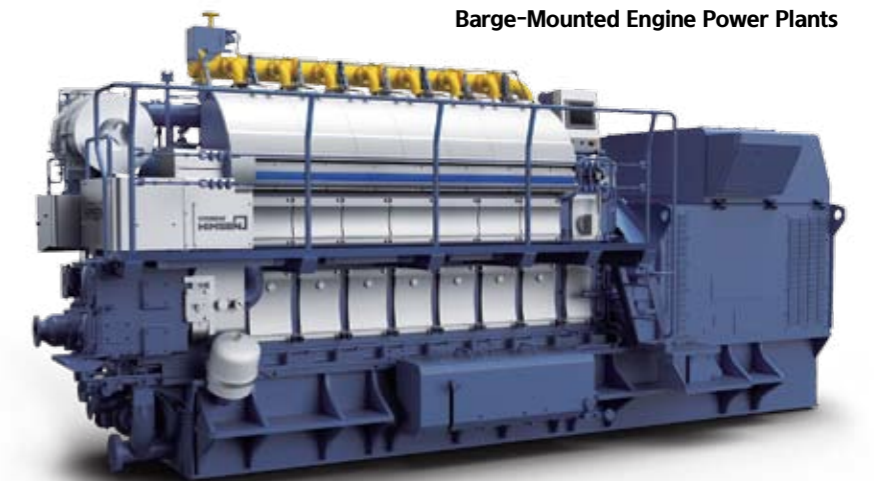



# HHI-EMD PRODUCTS

MARINE ENGINE

PROPELLER & SHAFT

COMPONENT

MARINE MACHINERY

ENGINE POWER PLANT



# 2-Stroke Engine

HHI-EMD has supplied "One out of Three" of the world's two-stroke engines for marine propulsion and power generation in pursuit of providing our valuable customers with high quality and economical solutions.

HHI-EMD's established reputation is supported by its superb performance in marine and stationary engines along with its state-of-the-art facilities such as foundry, machining, crankshaft, assembly and test shops.



1

1. HYUNDAI-WÄRTSILÄ 14RT-flex96C

## Main Products

• Hyundai-MAN Diesel & Turbo

• Hyundai-WinGD

• Engine Components



2



3



4



5

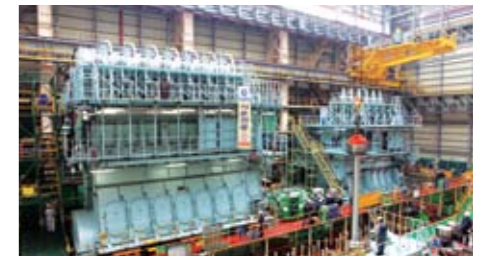

6

- 2. 2-stroke Engine Assembly & Test Shop
- 3. HYUNDAI-WÄRTSILÄ 12RT-flex96C
- 4. HYUNDAI-MAN B&W 8S70ME-GI
- 5. HYUNDAI-WÄRTSILÄ-W9X82
- 6. HYUNDAI-MAN B&W 7G80ME-C

## Components

- Bed plates
- Cylinder heads
- Piston rods

- Frame boxes
- Cross head pins
- Connecting rods

- Cylinder liners
- Cylinder frames



Frame Box



Cross Head Pin



Cylinder Head



Bed Plate



Cylinder Frame



Cylinder Liner



Piston Rod



Connecting Rod



# 4-Stroke HiMSEN Engine

HiMSEN engines are medium speed 4-stroke engines that HHI developed on its own after 10 years of R&D, and can be used for ship propulsion, power generation as well as at onshore plants. Since the first production of 4 units in 2001, HHI-EMD has delivered more than 10,000 units of this HiMSEN engines to 550 clients from 43 countries.

The HiMSEN engine features light-weight, high-output and high-efficient design and a wide range of lineup with models that can run on diesel and natural gas.

HiMSEN engine's superior design has also been recognized in the market by winning design awards at the 2010 International Forum (iF) Design Award and Red Dot Design Award 2010 and the Federal Republic of Germany Design Award.



## Main Products

- HiMSEN 4-stroke Diesel Engines
- HiMSEN 4-stroke Gas Engines
- HiMSEN 4-stroke Dual Fuel Engines
- Components



1. HiMSEN Engine Assembly & Test Shop
2. HiMSEN H35/40GV
3. HiMSEN H35DF
4. HiMSEN H46/60V
5. HiMSEN H21C

## Rated Power for Marine GenSets

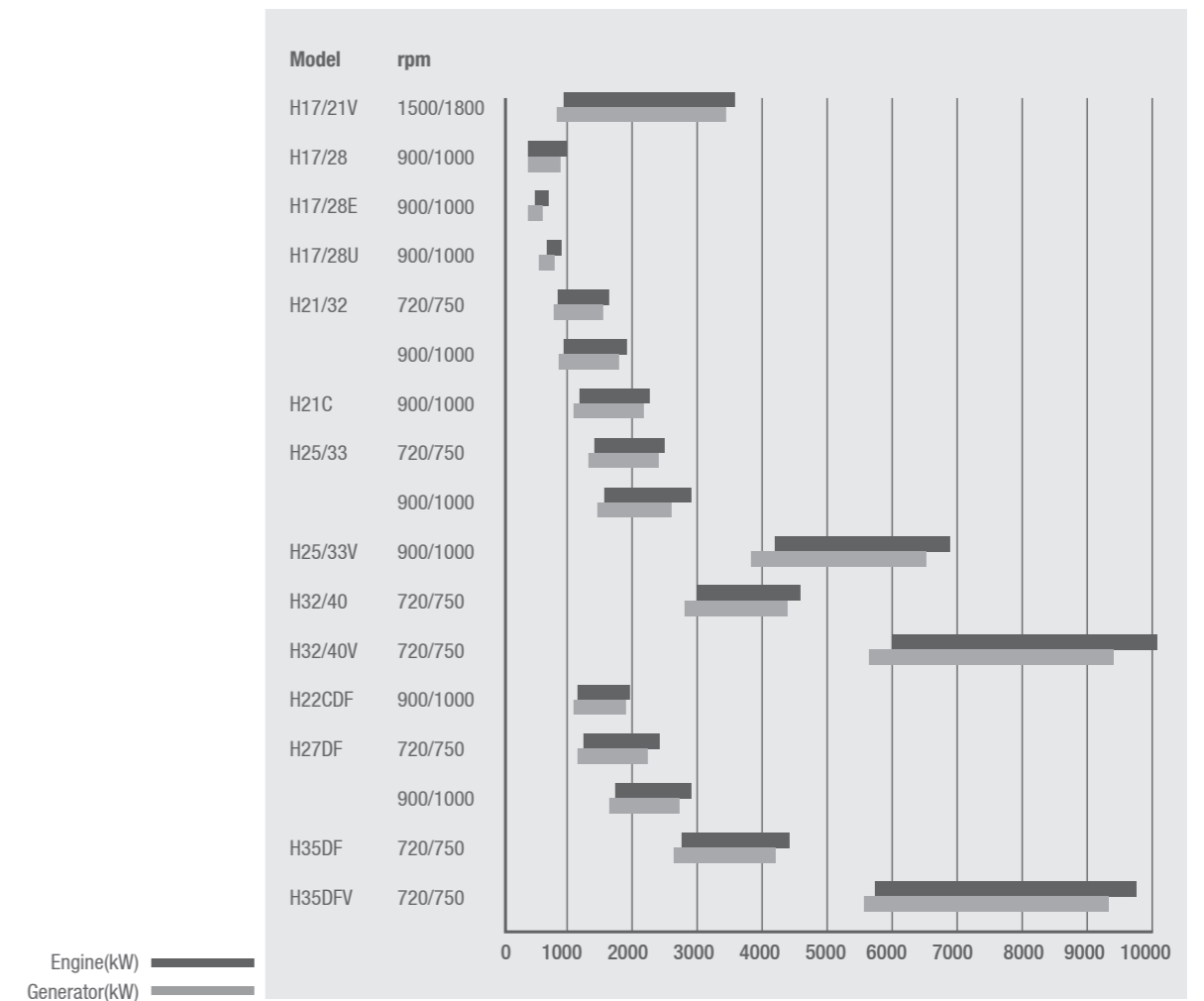

## Components

- Engine Blocks
- Cylinder Liners
- Connecting Rods
- Cylinder Head
- Pistons
- Piston Crowns
- Re-engine Services



Piston



Engine Blocks



Connecting Rod



Cylinder head



Cylinder Liner



# HiMSEN Propulsion System

HHI-EMD provides the HiMSEN Propulsion System with reliable, cost effective and environment-friendly solutions.

**The optimized package includes:**

- HiMSEN Diesel or Dual fuel engines
- C.P/F.P Propeller with shafting, Azimuth thruster
- Pitch and speed control
- Load control
- Reduction gear
- Shaft generator
- Auxiliary machinery

**Performance Highlights**

- Improved transient operation with pulse charging turbocharger
- Invisible smoke
- Lower thermal load engine
- Low fuel consumption
- Low NOx emission

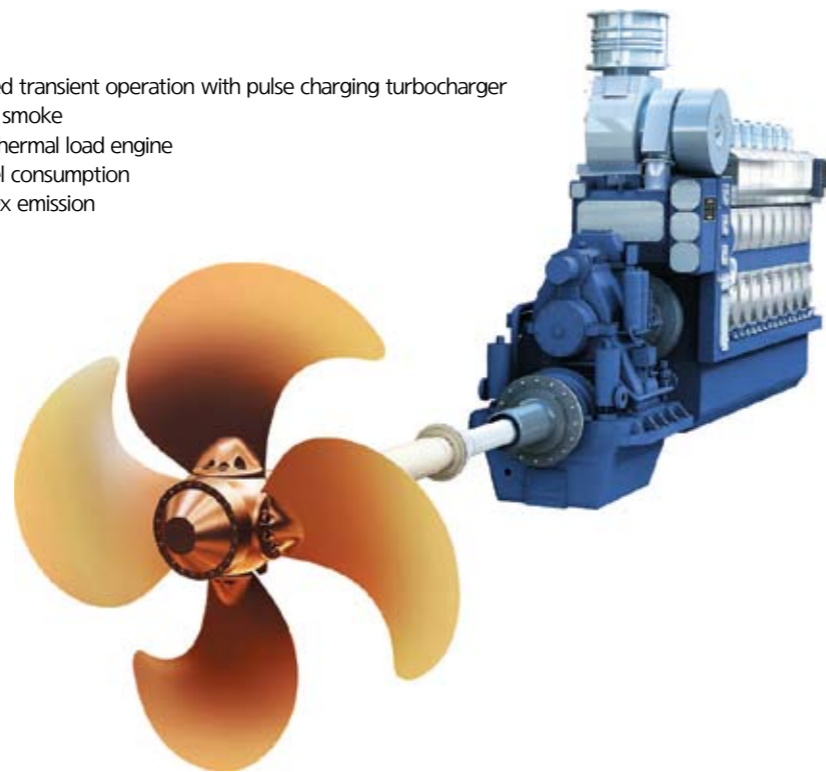

**Applications**

- Controllable pitch propulsion
- Fixed pitch propulsion
- Azimuth thruster propulsion
- Pump drive

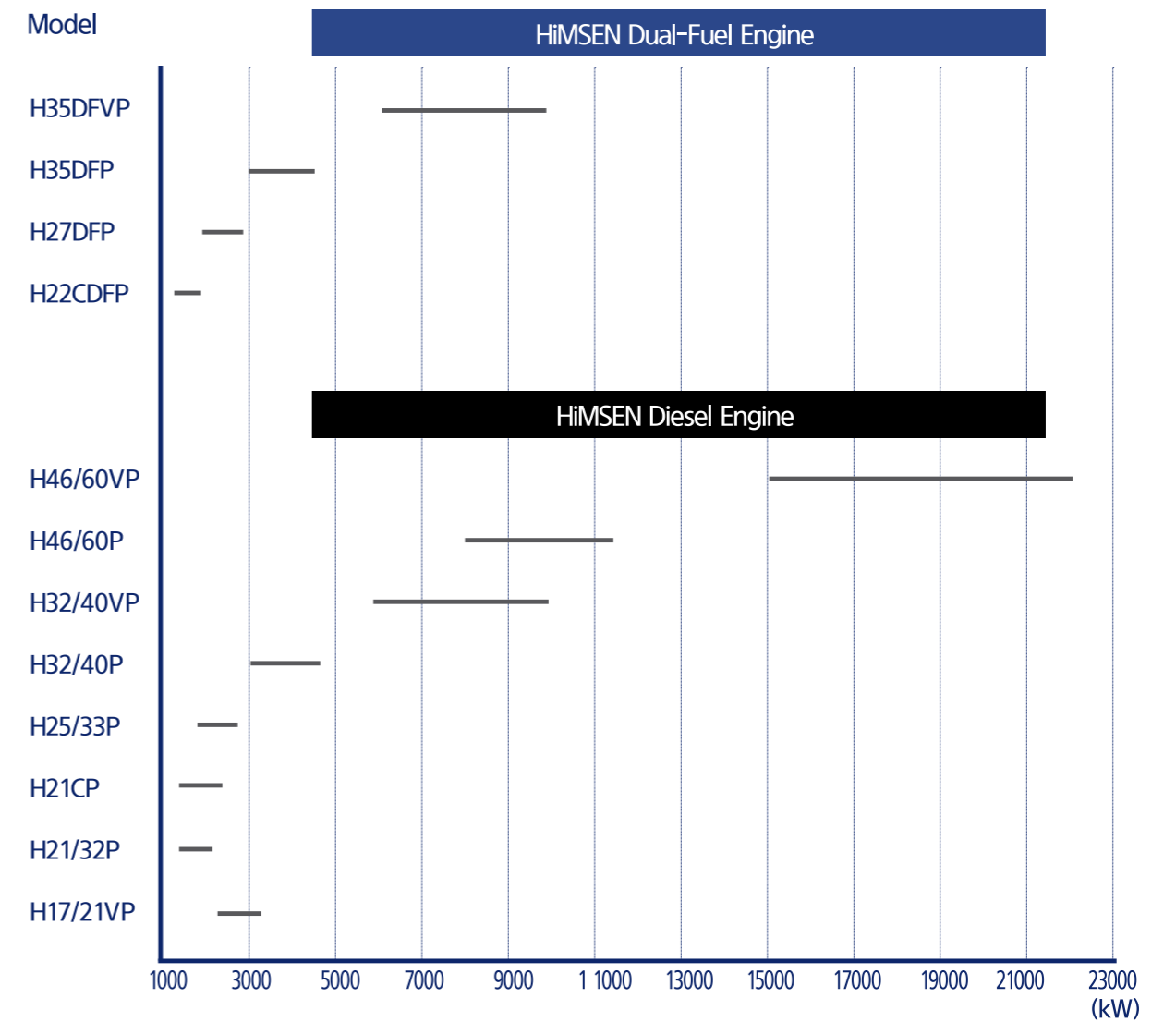

**Power Range**

HiMSEN Dual-Fuel Engine		HiMSEN Diesel Engine	
H22CDFP	1,100 - 1,980 kW	H17/21VP	1,920 - 3,200 kW
H27DFP	1,860 - 2,790 kW	H21/32P	1,200 - 1,800 kW
H35DFP	3,000 - 4,500 kW	H21CP	1,200 - 2,160 kW
H35DFVP	6,000 - 10,000 kW	H25/33P	1,740 - 2,610 kW
		H32/40P	3,000 - 4,500 kW
		H32/40VP	6,000 - 10,000 kW
		H46/60P	7,500 - 11,250 kW
		H46/60VP	14,400 - 22,500 kW



## HiMSEN Propulsion System

### HiMSEN Dual Fuel Engines for Propulsion

Model		H22CDFP	H27DFP	H35DFP	H35DFVP	
<b>Bore</b>	mm	220	270	350	350	
<b>Stroke</b>	mm	330	330	400	400	
<b>Speed</b>	r/min.	1,000	1,000	750	750	
<b>Cylinder output</b>	kW/ cyl.	220	310	500	500	
	cyl.	kW				
<b>Rated output #)</b>	5	1,100				
	6	1,320	1,860	3,000		
	7	1,540	2,170	3,500		
	8	1,760	2,480	4,000		
	9	1,980	2,790	4,500		
	12				6,000	
	14				7,000	
	16				8,000	
	18				9,000	
	20				10,000	
<b>SFOC *) on Diesel mode</b>	at 100% MCR	g/kWh	192.0	186.0	185.0	185.0
	at 85% MCR		196.0	185.0	184.0	184.0
<b>Heat rate *) on Gas mode</b>	at 100% MCR	kJ/ kWh	8,079	7,728	7,270	7,270

\*) Note

- 1) Reference condition based on ISO 3046/1
- 2) Fuel oil based on LCV (Lower Calorific Value) 42,700kJ/kg
- 3) Gas operation: Including pilot fuel oil and fuel gas based on LHV (Lower Heating Value) 35MJ/Nm<sup>3</sup>, MN80
- 4) Tolerance +5% and without engine driven pumps
- 5) NOx Emission limitation: IMO Tier II on Diesel mode, IMO Tier III on Gas mode
- #) Based on the CPP Constant speed operation (For FPP : Please contact HHI EMD)

### HiMSEN Diesel Engines for Propulsion

Model		H21/32P	H21CP	H25/33P	H32/40P	H46/60P	H17/21VP	H32/40VP	H46/60VP	
<b>Bore</b>	mm	210	210	250	320	460	170	320	460	
<b>Stroke</b>	mm	320	330	330	400	600	210	400	600	
<b>Speed</b>	r/min.	900	900	900	750	600	1,800	750	600	
<b>Cylinder output</b>	kW/ cyl.	200	240	290	500	1,250	160	500	1,250	
	cyl.	kW								
<b>Rated output #)</b>	5		1,200							
	6	1,200	1,440	1,740/ 1,800	3,000	7,500				
	7	1,400	1,680	2,030	3,500	8,750				
	8	1,600	1,920	2,320	4,000	10,000				
	9	1,800	2,160	2,610	4,500	11,250				
	10									
	12						1,920	6,000	15,000	
	14							7,000		
	16									
	18						2,560	8,000	20,000	
	20						2,880	9,000	22,500	
	<b>SFOC *) on Diesel mode</b>	at 100% MCR	g/kWh	183.0	183.0	181.0	184.0	177.0	199.0	186.0
at 85% MCR		183.0		179.0	181.0	181.0	174.0	196.0	181.0	174.0

\*) Note

- 1) Reference condition based on ISO 3046/1
- 2) Fuel oil based on LCV (Lower Calorific Value) 42,700kJ/kg
- 3) Tolerance +5% and without engine driven pumps
- 4) NOx Emission limitation: IMO Tier II
- 5) H17/21VP Model: Only applicable on MGO operation
- #) Based on the CPP Constant speed operation (For FPP : Please contact HHI EMD)



# Propeller & Shaft

HHI-EMD produces a wide variety of marine propellers with a diameter up to 11 meters and a maximum unit weight of 114 tons. The main materials are manganese bronze and nickel-aluminum bronze.

HHI-EMD employs a comprehensively computerized design, manufacturing and inspection system for these products.

## Propeller Shop

- **Maximum:** 114 tons in Weight, 11 m in Diameter
- **Minimum:** 10 tons in Weight, 3 m in Diameter
- **Machining Equipment:** NC Blade Milling M/C x 3 sets
- Boss Boring M/C x 3 sets
- Riser Cutting M/C x 2 sets
- Horizontal Balancing M/C x 2 sets



1



1. World's Largest Propeller  
 Weight 110.2 tons  
 Diameter 10.4 m  
 Blade 5  
 Shiptype 18,800 TEU Container-ship

## Shaft & Rudder Stock

- Products**
- Propeller shaft
  - Intermediate shaft
  - Straight type rudderstock

- Max. Production**
- 150 tons in Weight
  - 2,200 mm in Diameter
  - 18,000 mm in Length

- Min. Production**
- 300 mm in Diameter
  - 2,000 mm in Length





# Crankshaft

HHI-EMD produces semi-built-up and mono-block crankshafts, using the most up-to-date CNC and NC heavy-duty crankshaft and crank-throw lathes.

## Main Products

- 2-stroke engine crankshaft
- 4-stroke engine crankshaft



1



2

- 1. 2-stroke Engine Crankshaft Assembly
- 2. 4-stroke Engine Crankshaft



# Turbocharger

Based on its wealth of experience and technology in manufacturing engines and precision machinery, HHI-EMD produces exhaust gas turbochargers under a technical tie-up with ABB Turbo Systems and Mitsubishi Heavy Industries (MHI).



## Main Products



ABB TPL & A Type: A165 / A265 / A270 / A175 / A275 / A180 / A280 / A185 / A285 / A190



MHI's MET Type: MET66MB / MET71MB / MET83MB / MET90MB



# Hi-Well Cargo Pumping System



Hi-Well Cargo Pumping System is based upon hydraulically driven submerged cargo pumps for chemical and product carriers, crude carriers, FPSO units and others.

The system is designed for efficient cargo handling, stripping and tank cleaning. Hi-Well is designed, manufactured and factory-tested by computer-aided technology and the most qualified expert engineers.

### Components

#### Major

- Hi-Well cargo pump
- Hydraulic power package
- Control system
- Ballast pump
- Portable pump with winch
- Tank cleaning pump
- Hydraulic oil transfer pump

#### Optional

- Diffuser
- Side thruster & Control block
- Cargo heater

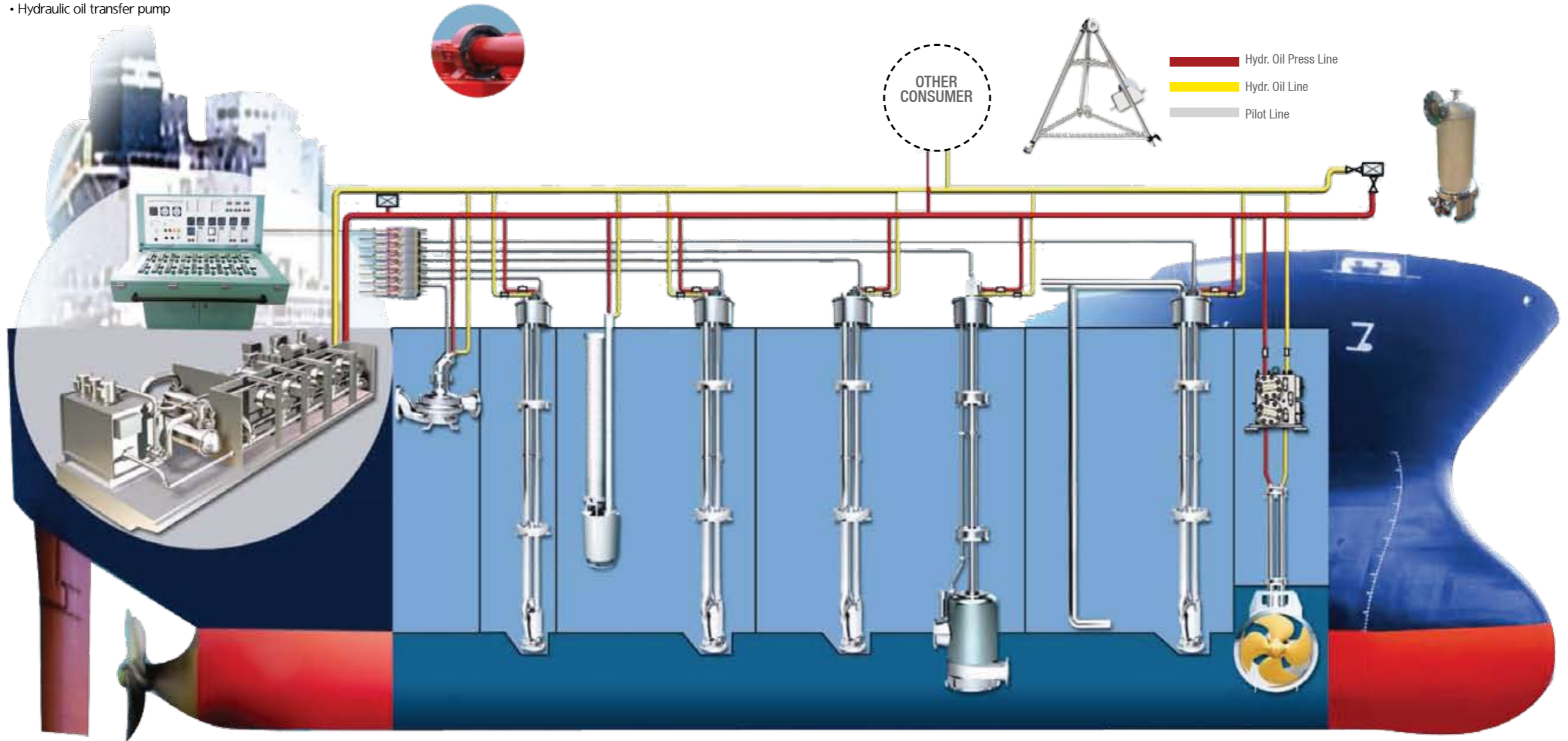

### How It Works

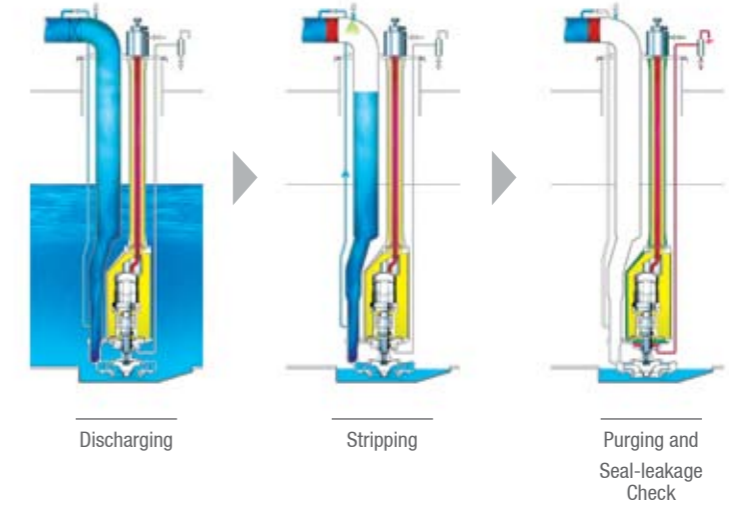



# Hi-GAS Hyundai integrated Gas Supply System



## Packaged Solution: LNG Fuel Gas Supply System

As the LNG market is steadily developing due to the environmental and economic benefits, the demand for LNG carriers and LNG-fueled ships is increasing. As high-efficient dual-fuel engines become a preferred prime mover choice for the engine market, HHI-EMD is readily lined up with both ME-GI engines and 4-stroke dual-fuel HIMSSEN engines.

Hi-GAS is a remarkable design of LNG fuel gas supply system for dual-fuel engines based on high- and low- pressure supply. Hi-GAS can effectively supply high-pressure compressed natural gas (CNG) to ME-GI engines while supplying low-pressure CNG to 4-stroke DF GenSets, which operate with two fuel supply systems.

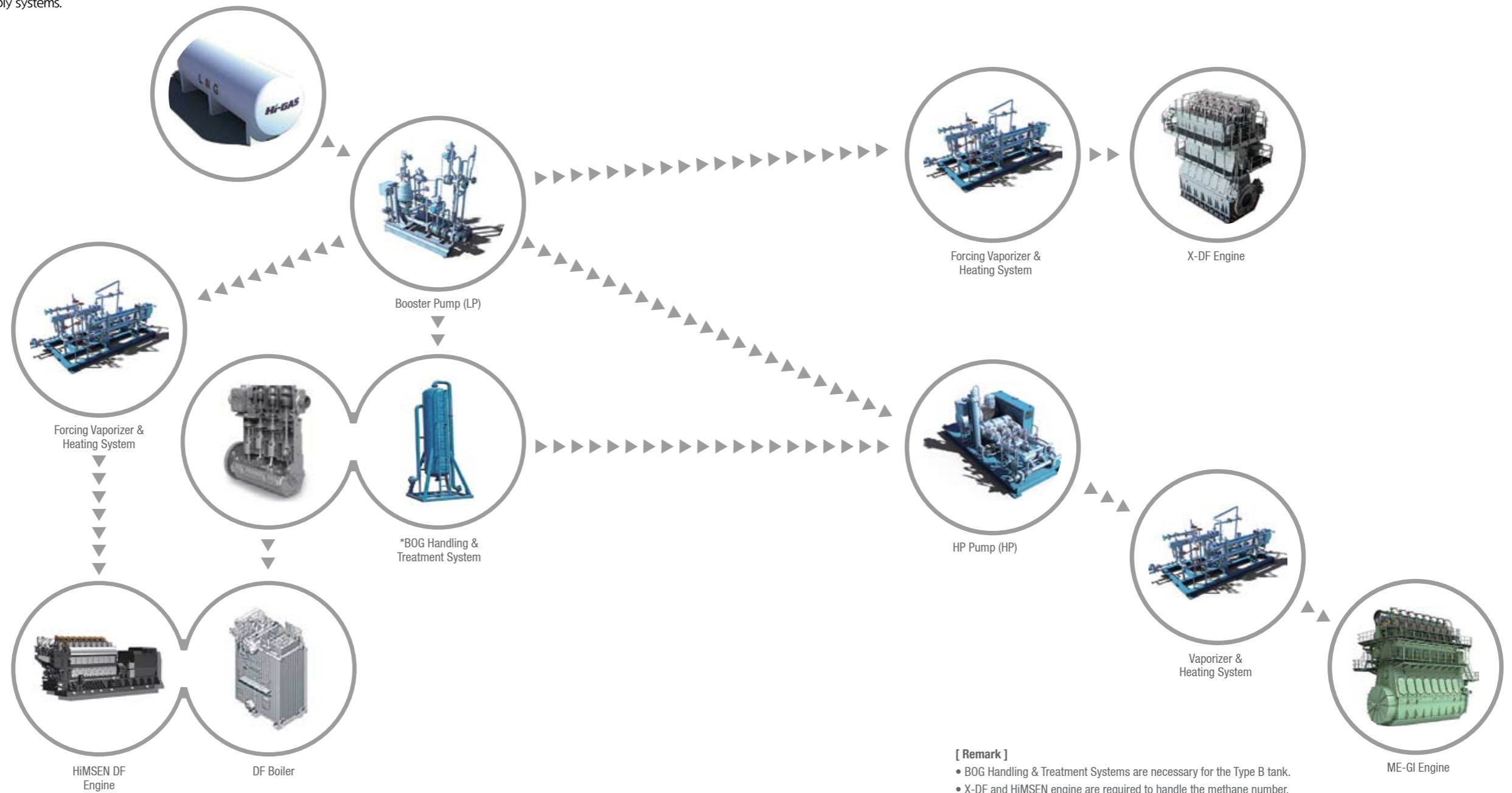

## Applications

HHI-EMD is lined up with the complete range of LNG packaged solutions for LNG carriers and LNG-fueled ships.





# Hi-ERS Hyundai Innovative Economical Re-liquefaction System



HHI-EMD has developed Hi-ERS, Hyundai Innovative Economical Re-liquefaction System that can partially liquefy the boil-off gas (BOG) of LNG carriers by combining the high-pressure compressor for ME-GI engines.

Hi-ERS features simple configuration, robust operation, reliable components and high safety system satisfying the requirements of customers.

To achieve energy saving through recovering cold energy from the system, the highly efficient and compact plate type BOG heat exchanger is installed between the LNG cargo tank and the suction of high-pressure compressor. The BOG heat exchanger is intended to cool down compressed BOG by cold heat from BOG which has temperature approximately between -120°C and -90°C and flash gas from LNG separator to improve the system efficiency of Hi-ERS.

The Joule-Thomson valve expands the compressed BOG in its cold state to a targeted low pressure and simultaneously lowers it to the condensing temperature of BOG.

By using Hi-ERS, simple and economical re-liquefaction of BOG can be achieved.

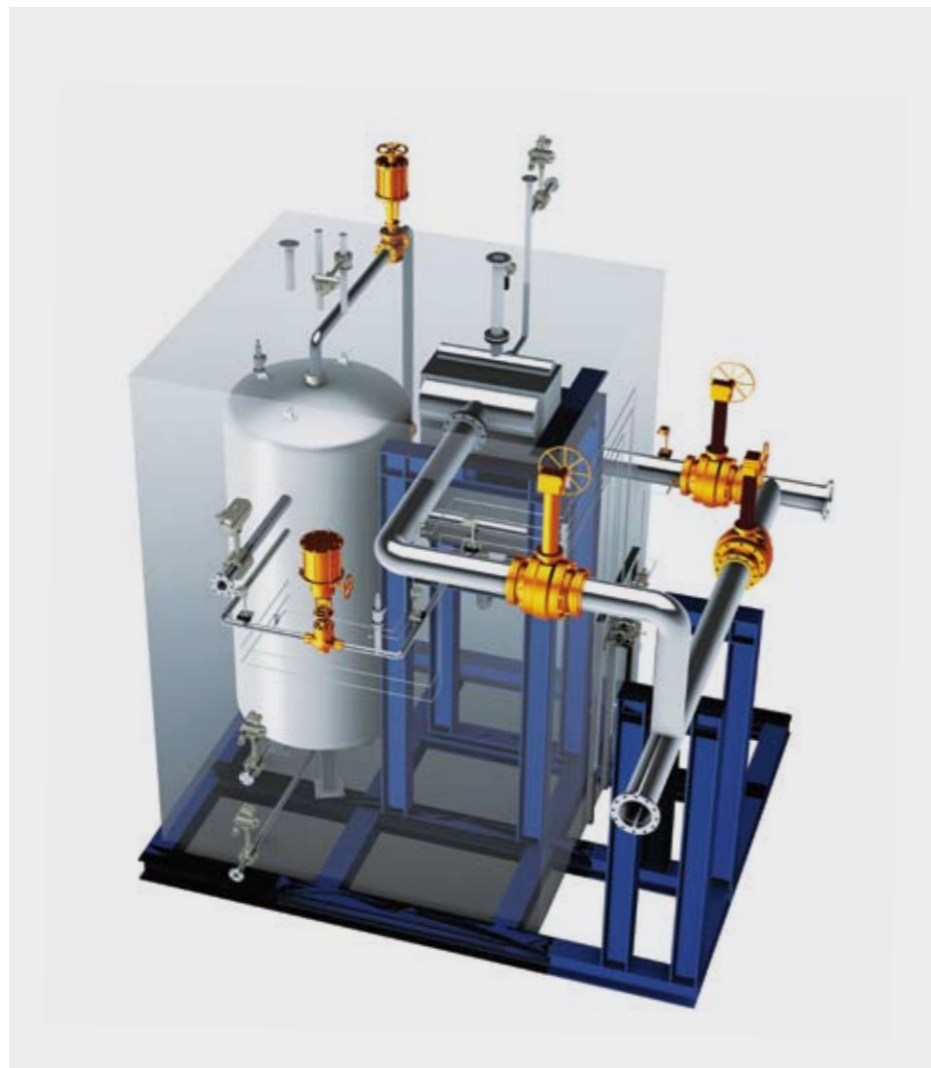

1

1. Hi-ERS basically consists of BOG heat exchanger, Joule-Thomson valve, and LNG separator.

## How It Works

The LNG carrier's cargo tanks are insulated for a slightly sub-cooled condition. LNG cargo handling system controls the BOG to prevent overpressure of the LNG cargo tank during transportation by removing or extracting BOG.

The High Pressure Compressor (HPC) primarily controls the cargo tank pressure and compresses the BOG with five-stage compressors to supply fuel gas to ME-GI engines for the propulsion.

In case the cargo tank pressure is over the pressure set-point, Hi-ERS will start to work.

- **Higher BOG Flow Rate Than Gas Demand**
  - Excessive BOG is sent to Hi-ERS through Joule-Thomson Valve and partially condensed.
  - Excessive BOG beyond ERS's capacity is compressed and sent to GCU, DF generator or boiler, etc.
- **Lower BOG Flow Rate Lower Than Gas Demand**
  - LNG fuel gas supply stems operates to control required gas pressure and amount.

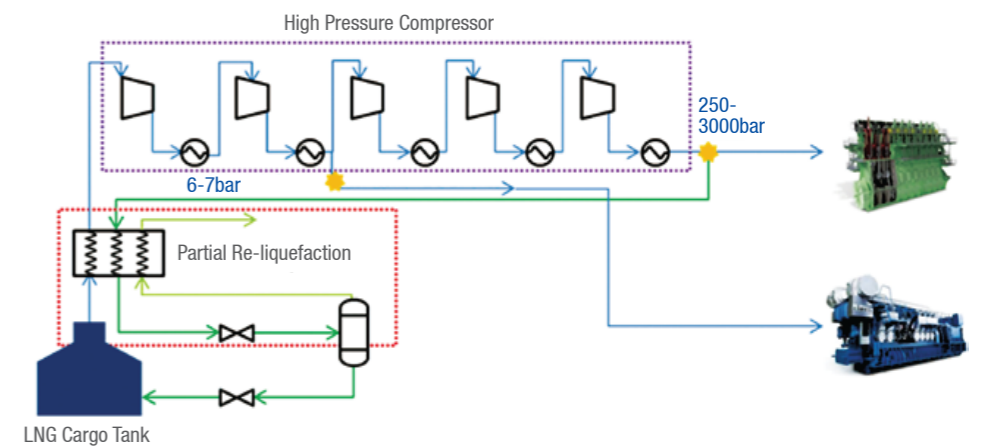

## Main Equipment

2. BOG Heat Exchanger
3. Joule-Thomson Valve (J-T valve)
4. LNG Separator



2 3 4



# Hi-ReGAS Hyundai Integrated Regasification System



HHI-EMD's Hi-ReGAS, Hyundai Integrated Regasification System is engineered to vaporize LNG and offload LNG onto onshore pipelines. Hi-ReGAS provides two types of LNG heating methods: seawater direct heating type and seawater/glycol-water indirect heating type.

The seawater direct heating type gives attractive benefits: low fuel consumption, low space occupation, easy operation and quick startup and shutdown.

The seawater/glycol-water indirect heating type has other advantages: lower corrosion risk and freezing risk. Hi-ReGAS provides notable features (optimized seawater pipeline routing and space utilization) through the optimal integrated configuration of both regasification module and hull sides.

Hi-ReGAS is mainly composed of LNG suction drums, booster pumps and vaporizers. The pump and vaporizer can be packaged in a modular way for each train.

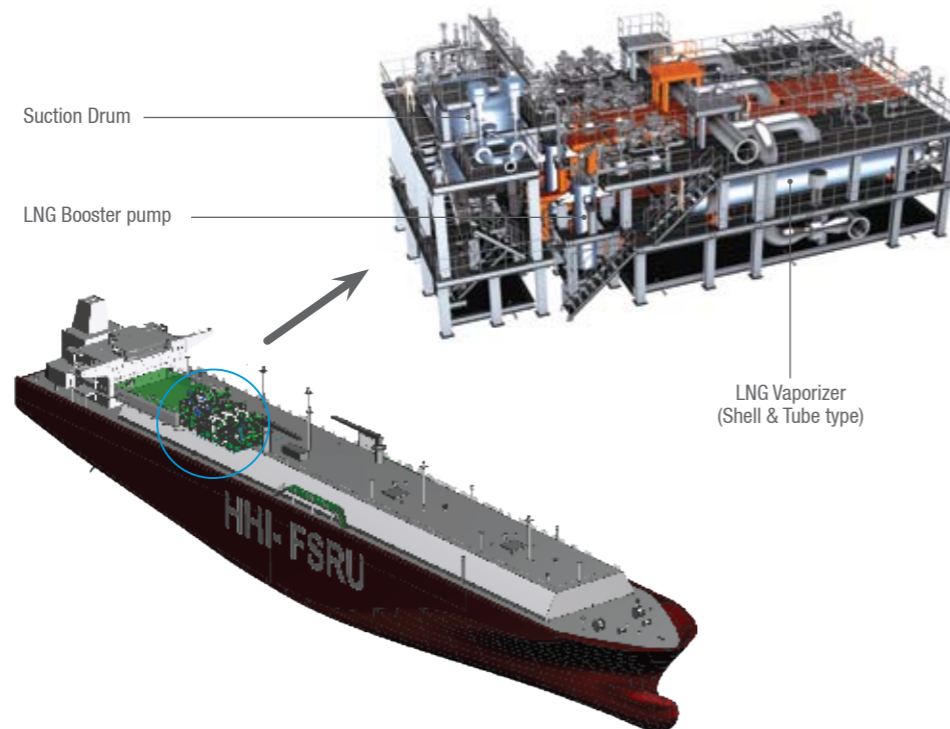

## Suction Drum with BOG Recondenser

The suction drum functions as a buffer tank for booster pumps. The internal packing material of the suction also provides BOG recondensing function by enhancing the contact surfaced between the compressed BOG and the subcooled LNG into the suction drum.

## LNG Booster Pump

Each train has an LNG booster pump with the rated capacity of 125 mmscfd at 100 bar head. The pumps are assorted into multistage, vertical, submerged, and pot-mounted types.

## LNG Vaporizer

LNG vaporizers are installed at each train to vaporize the LNG. In the process, the shell- and tube-type heat exchanger heats LNG with sea water in case of seawater direct heating type. In the case of the seawater/glycol-water indirect heating type, LNG vaporizers utilize glycol-water as a heating medium circulating in the closed loop.

## NG Heater (only for in-direct type)

NG heaters (printed circuit heat exchanger type, PHCE) are installed at the downstream of LNG vaporizers to increase NG temperature for the requirement of end user. The application of these heat exchangers can minimize the size and weight of the regasification trains.

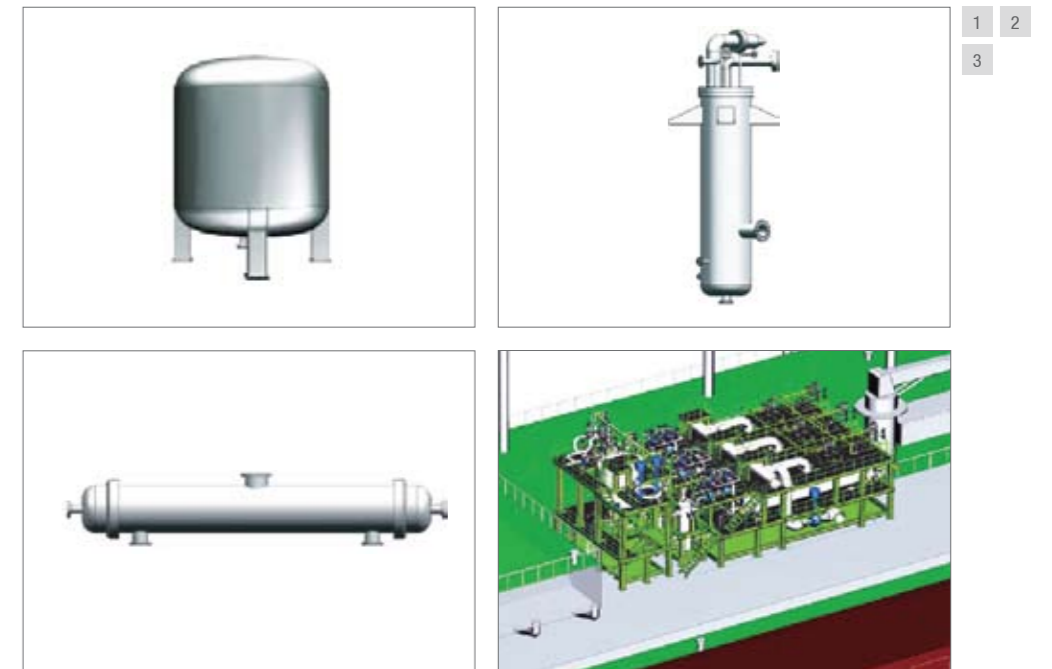

- 1. CSuction Drum with BOG Recondenser
- 2. LNG Booster Pump
- 3. LNG Vaporizer



# NoNOx™ Hyundai SCR (Selective Catalyst Reduction) System



NoNOx™ is a brand name of the Hyundai SCR (selective catalyst reduction) System that can reduce NOx up to 95% and meet IMO Tier III regulation.

- Most reliable design for marine application
- Best adoptability for onboard installation
- Most convenient for verification and operation

## Certification of NoNOx SCR System

SCR system and relevant certification procedure for marine application is defined by IMO.

According to resolution MEPC.198(62), SCR system is considered as an engine component. Therefore, instead of separate certification of SCR system, IMO NOx verification in combination with engine is required according to Scheme A and Scheme B.

NoNOx SCR system can be verified and receive IMO NOx Tier III certification at HHI-EMD test-bed according to Scheme A.

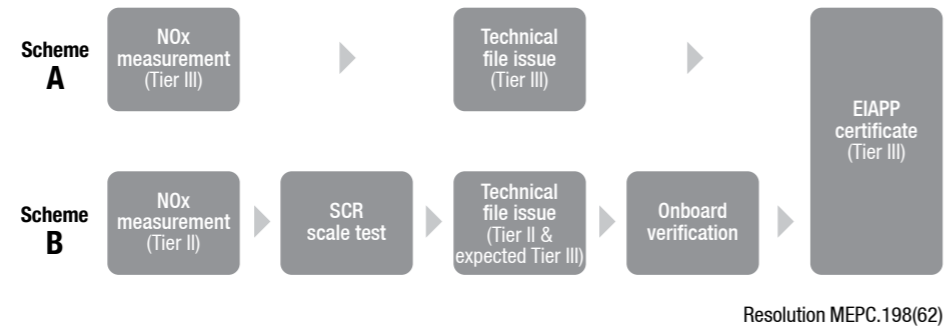

## Main Components

### LP SCR for 4-stroke engine

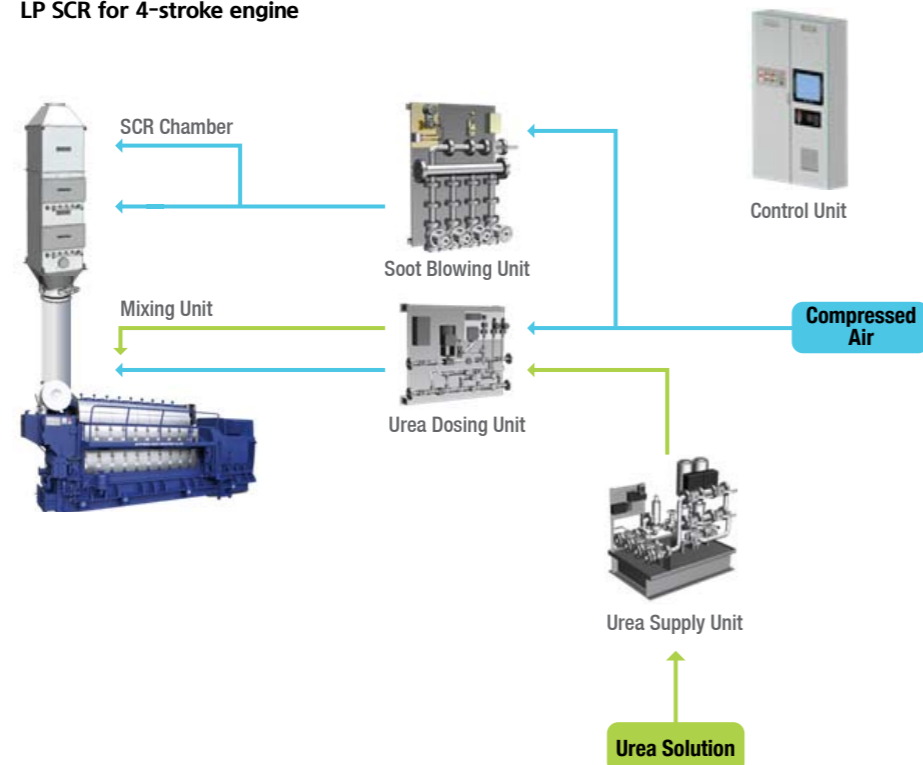

### HP SCR for 2-stroke engine

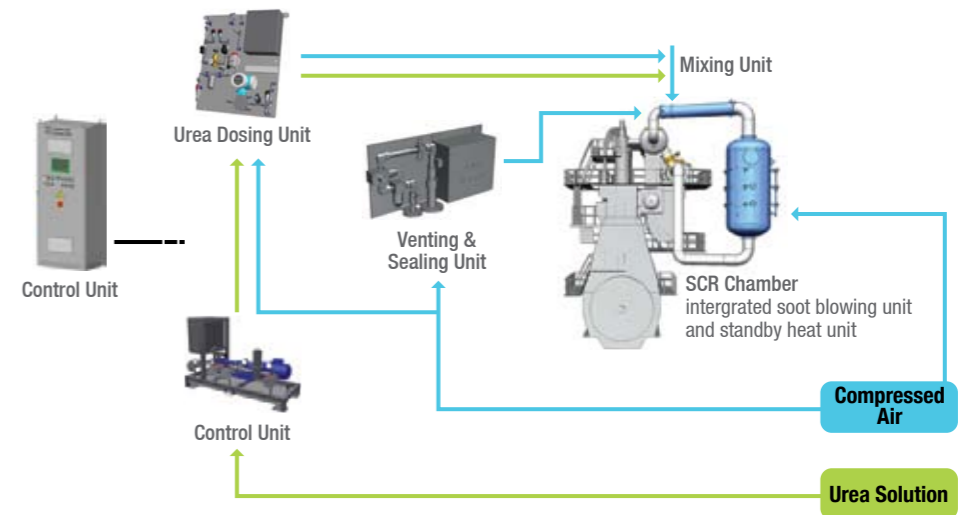

### LP SCR for 2-stroke engine

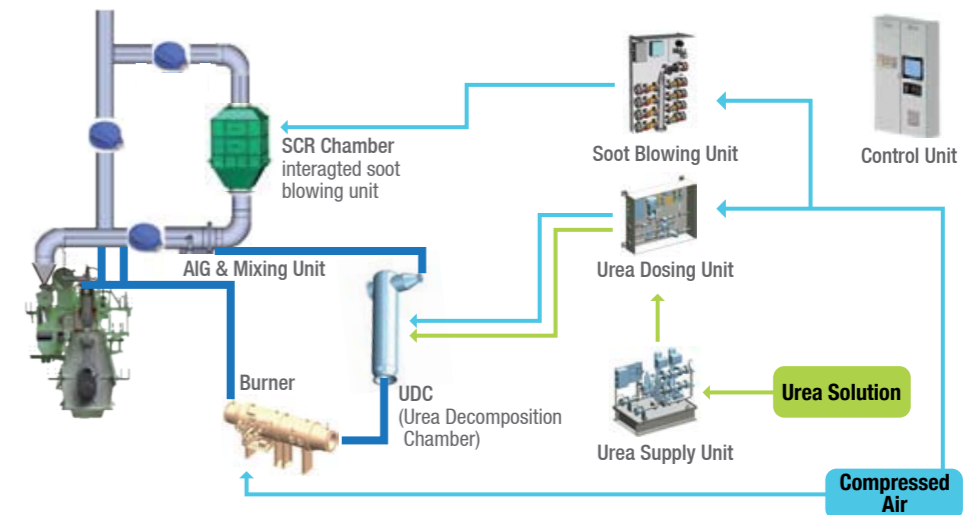

## NoNOx Mini-SCR

NoNOx Mini-SCR technology can offer more compact size and lower cost compared to the original SCR. The Mini-SCR is designed considering essential minimized engine load called 2nd-MCR only for Tier III mode because the engine generally would not run at high load in ECA(Emission Control Area). The engine load will be limited according to operating mode (Tier II or Tier III). Size of the Mini-SCR can decrease approx. 70~85% of original one, hence CAPEX and OPEX can be reduced.

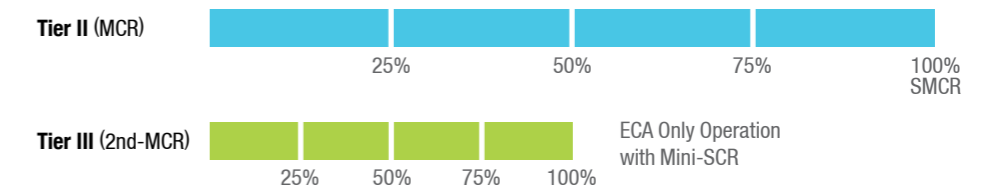



# HiBallast Ballast Water Treatment System



HiBallast is a disinfection system by electrolysis of seawater with the following characteristics:

- Components: Filter, Electrolysis Unit, Neutralization Unit, TRO Sensing Unit
- Required Sea Water Capacity for Electrolysis: only 1% of total ballast capacity
- Disinfectants: Sodium hypochlorite
- Neutralizing Agent: Sodium thiosulfate
- Safety First: No harm to human & vessel, No danger by H<sub>2</sub> gas separation, no risk of damage to ballast tank coating

## How it Works

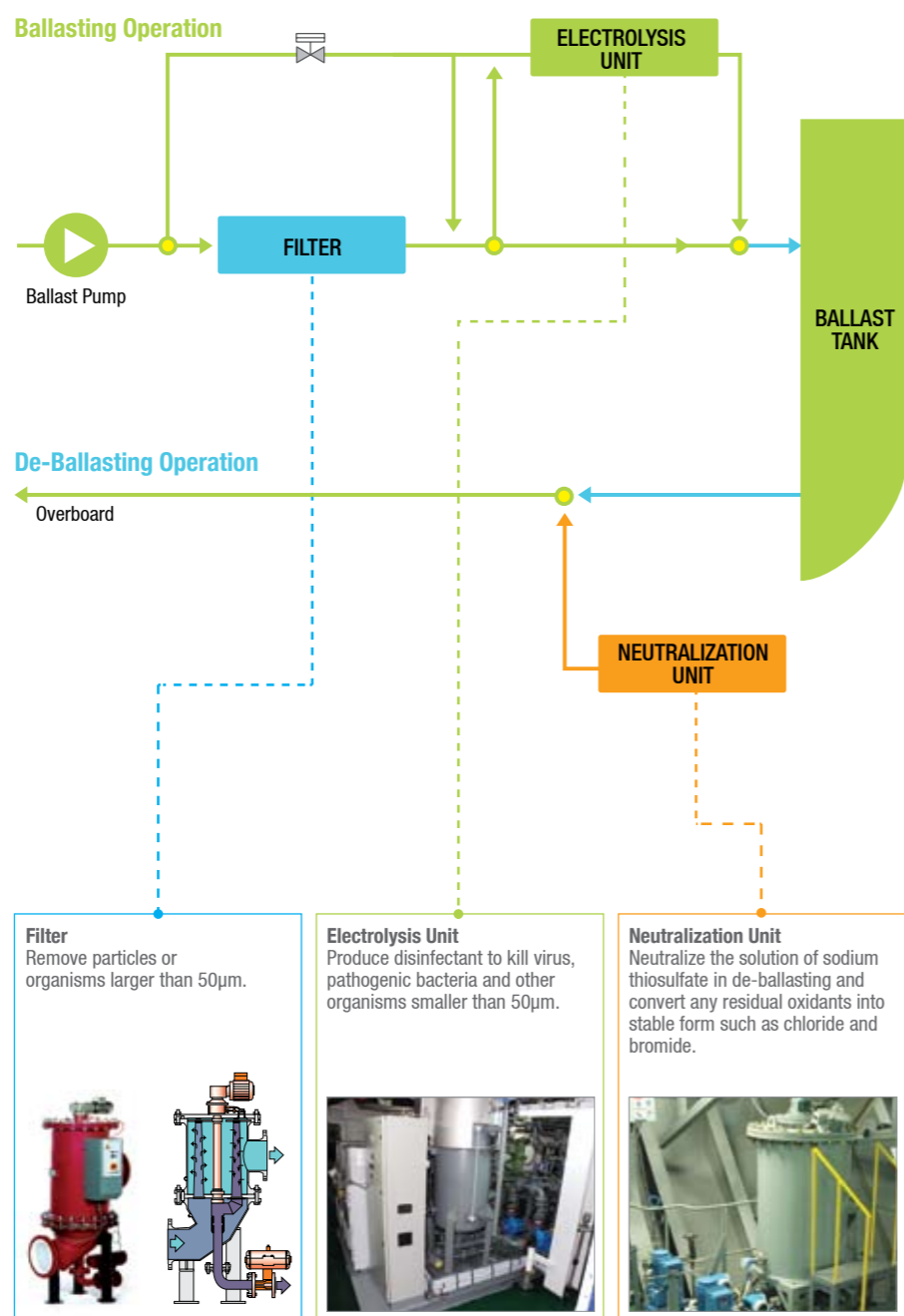

## Key Features & Benefits

- |                                       |   |
|---------------------------------------|---|
| <b>Easy Installation</b>              | <ul style="list-style-type: none"> <li>• No changes to the existing ship design</li> <li>• Space-saving installation with modular design, suitable for retrofit</li> </ul>  |
| <b>Automatic Operation</b>            | <ul style="list-style-type: none"> <li>• Feedback control of each unit with human-machine interface</li> <li>• Both automatic and manual operation</li> <li>• Automatic treatment rated capacity (TRC) control</li> </ul> |
| <b>Economic Operating Cost</b>        | <ul style="list-style-type: none"> <li>• Low fuel cost because of lower power consumption</li> <li>• Longer lifetime of electrodes</li> </ul>   |
| <b>Convenient maintenance and A/S</b> | <ul style="list-style-type: none"> <li>• Modular type system</li> <li>• Easy replacement for engineer/ship staff</li> <li>• Global support and worldwide A/S network</li> </ul>   |
| <b>Main application</b>               | <ul style="list-style-type: none"> <li>• Any vessel types including oil tankers, containerships and gas carriers</li> <li>• Ballast water capacity: 75 to 10,000 m<sup>3</sup>/hr</li> </ul>                              |

## Control System Configuration

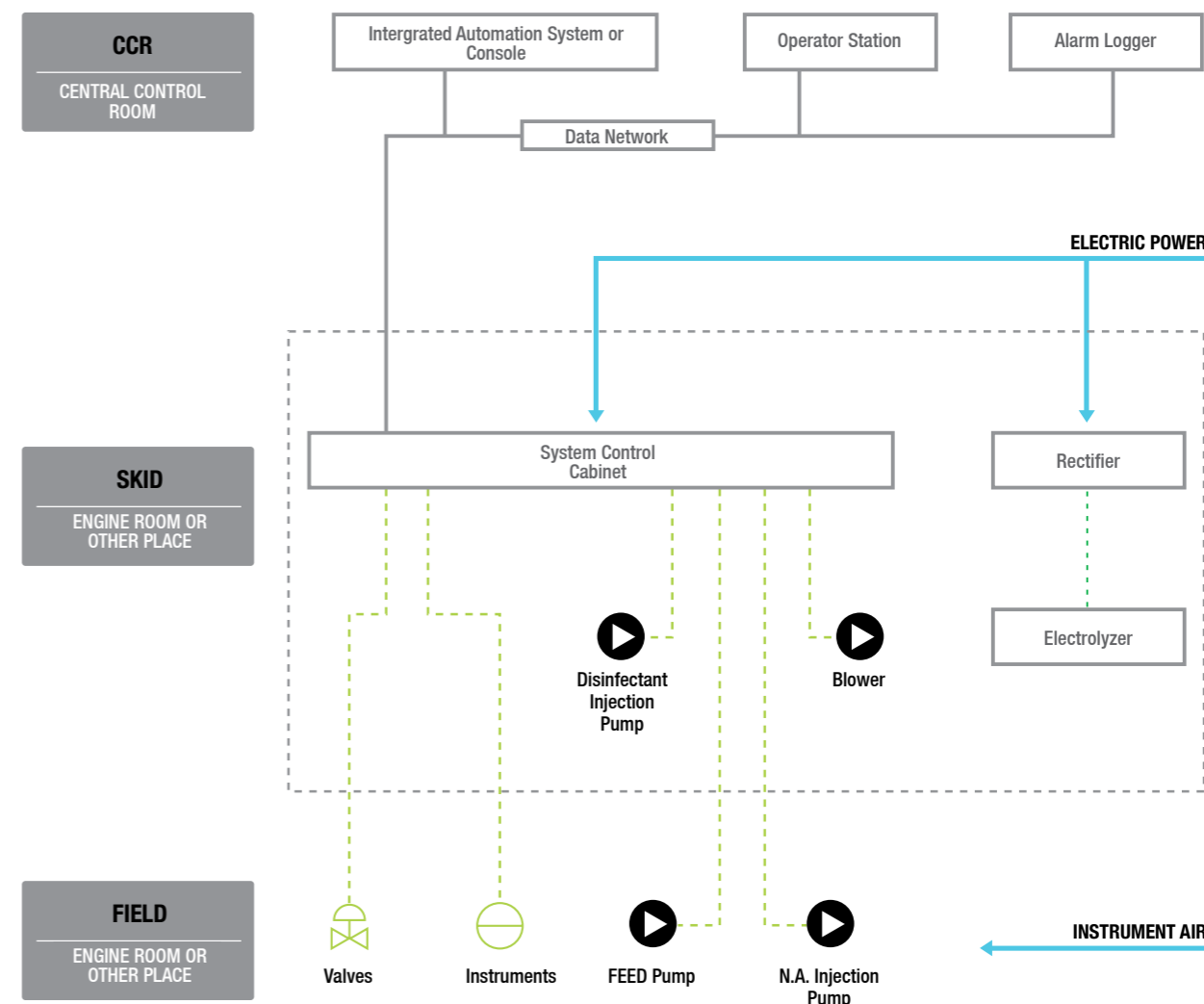



# EcoBallast Ballast Water Treatment System

**EcoBallast™**

EcoBallast is an ultra-violet disinfection system with the following characteristics:

- **Components:** Filter, UV Reactor, CIP (Cleaning In Place) Unit
- **Disinfectants:** UV-C light
- Environment-friendly disinfection process
- **Safety First:** Not harmful to human and vessel

## How it Works

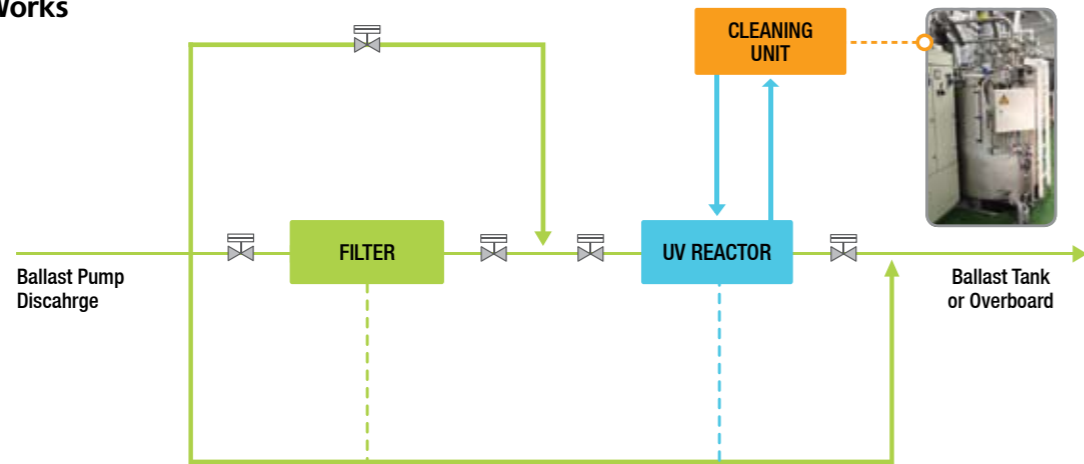

**Filter**  
Remove particles or organisms larger than 50µm.

**UV Reactor**  
Disinfect virus, pathogenic bacteria and other organisms smaller than 50µm.

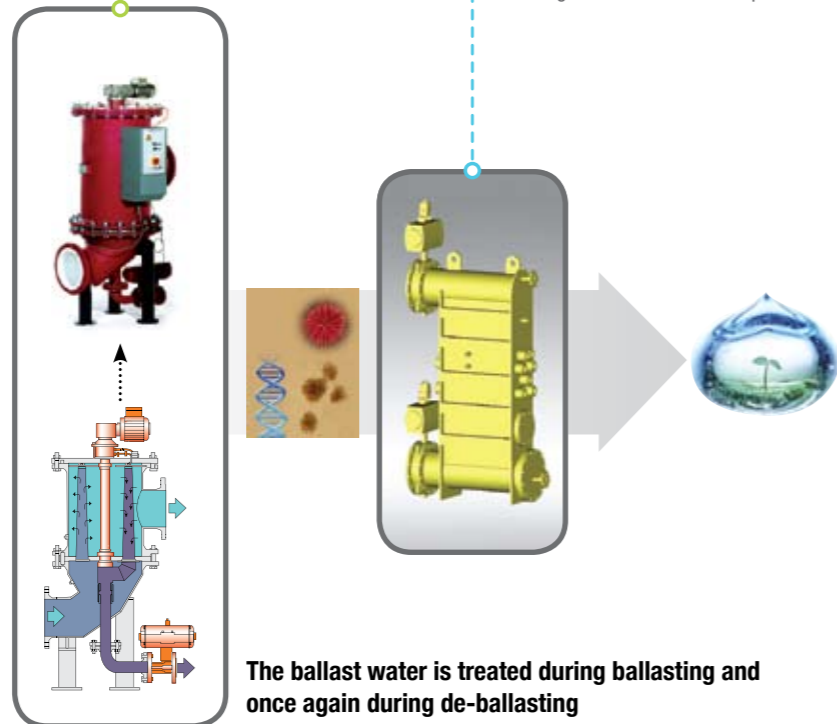

The ballast water is treated during ballasting and once again during de-ballasting

## Main Features



- Filter**
- High performance
  - Small footprint
  - Full automation
  - Easy maintenance
  - Low maintenance cost

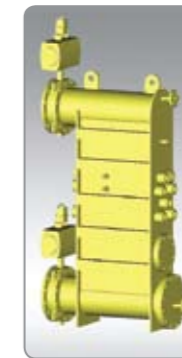

- UV Reactor**
- Highly efficient
  - Unique and robust design
  - Automatic TRC (treatment rated capacity) control

- Electronic Ballast Device**
- High reliability and efficiency
  - Longer lifetime

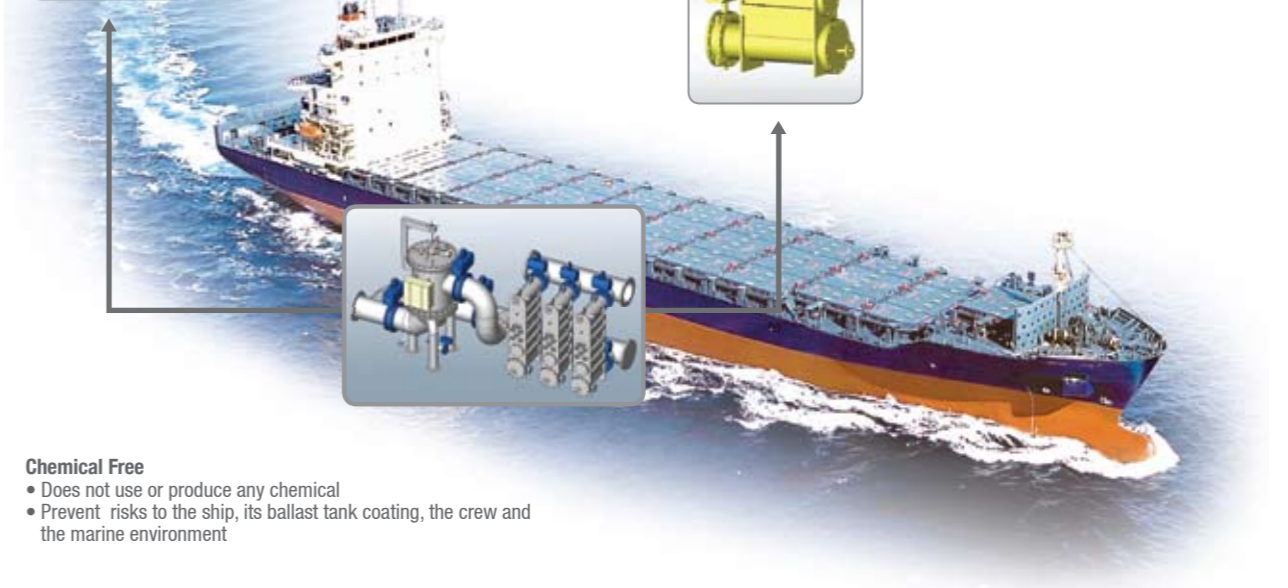

- Chemical Free**
- Does not use or produce any chemical
  - Prevent risks to the ship, its ballast tank coating, the crew and the marine environment

## Control System Configuration

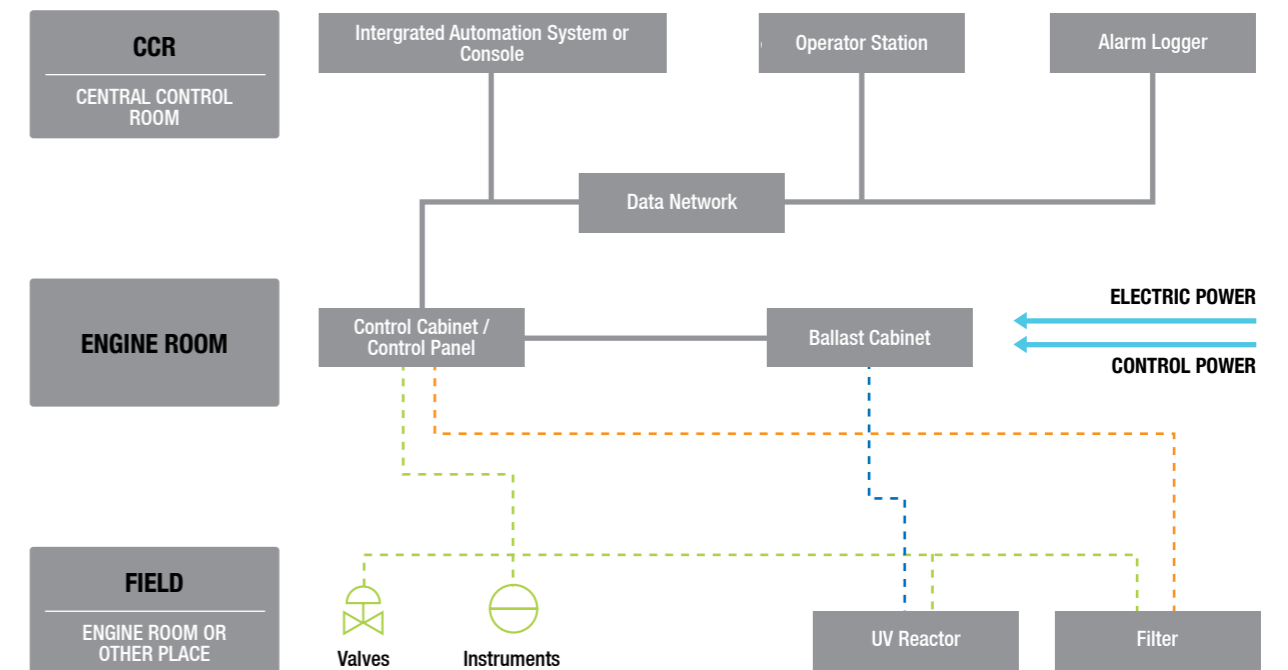



## HiEMS Hyundai Intelligent Engine Monitoring System



HiEMS, HiMSEN Engine Monitoring System offers a real-time engine status and transfers alarm and fault messages to remote offices and staff when detecting the abnormalities. HiEMS provides troubleshooting clues to marine engineers in detail, while onshore service engineers receive operational data for failure analysis.

### How It Works



**Engine Status Monitoring**  
Display main TAG of all engines and detail monitoring of specific engine.



**Trend Analysis**  
Real-time/History View engine operation over time and detect the abnormalities early.



**Alarm/Fault Management**  
Managing the log data deviated from the criteria of the alarm/fault configured initially and spreading to onboard and onshore office.

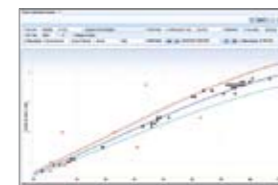

**Performance Curve based Analysis**  
Display performance status in comparison to the result of 'official shoptest' considering engine load.



**Deviation based Analysis**  
Display deviation from the average of cylinders, turbochargers.

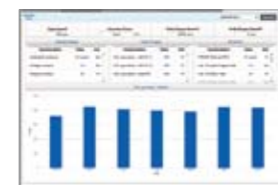

**Remote Monitoring**  
Display overall status of engine and alarm/fault event from the vessel. Provide the report that contains engine performance data.

### Key Features & Benefits

- Real-time engine status monitoring and analysis reporting
- Signal data spreading of alarm/fault by e-mail.
- Data transfer of engine operation and performance analysis
- Self-diagnosis by 'interactive failure cause analysis program'
- Easy engine status monitoring, performance measuring and reporting
- Service of variable information to be checked by additional process during specific period
- Prompt check detects and engine status information in remote sites
- Service of specific technical assistant from special engineers

## HiCAS Hyundai Intelligent Combustion Analysis System



Hi-CAS is an on-line engine indicating system to acquire and process in-cylinder pressure data referenced to crank angle. Once data is loaded into the analysis software, engine's thermodynamic cycle is analyzed on the cycle-to-cycle and cylinder-to-cylinder basis.

To achieve optimum thermodynamic and mechanical engine behavior during entire life cycle, HiMSEN engines give two kinds of on-line monitoring applications. This diagnostic package helps detect engine abnormalities more quickly and save maintenance cost.

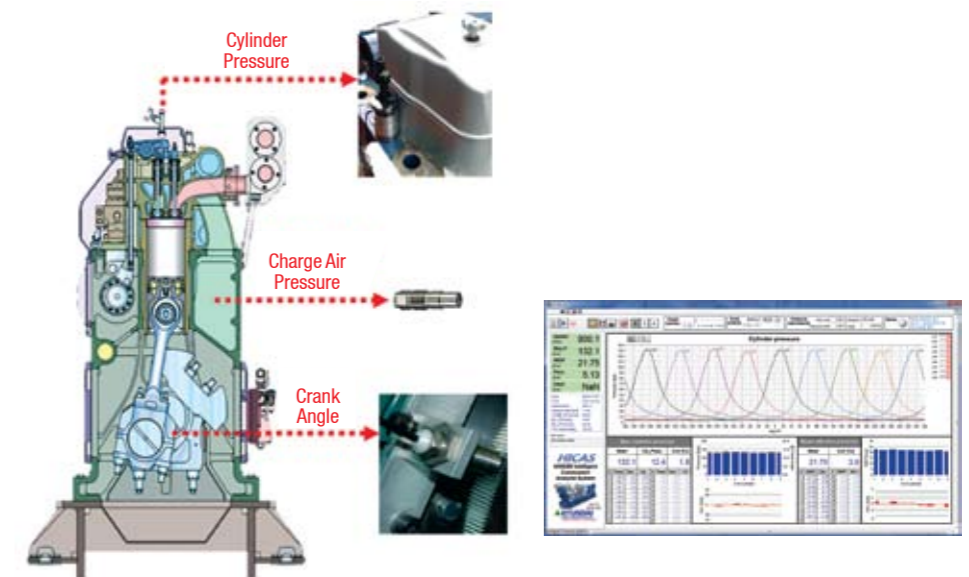

### Key Features & Benefits

- In-cylinder peak pressure & IMEP monitoring
- Cycle-to-cycle variation
- Cylinder-to-cylinder distribution
- Fault diagnosis of cyclic moving parts

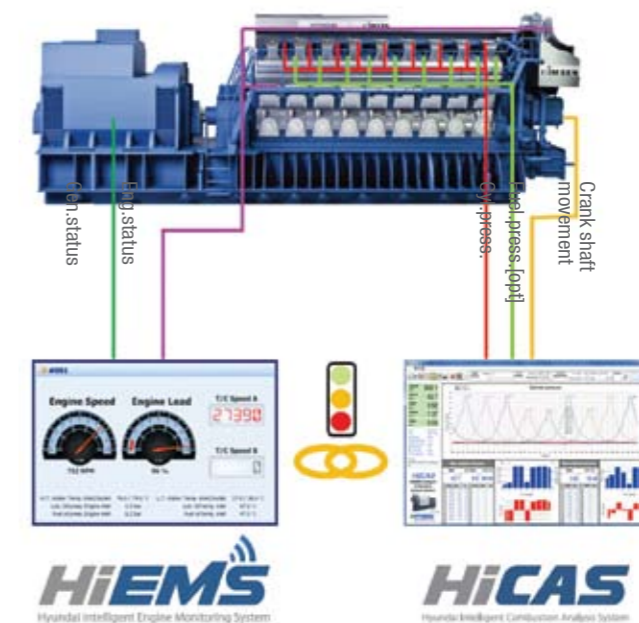



# Engine Power Plant

## Prime Mover: 2-Stroke Engine

Since the first completion of 20MW-diesel power plant in Jeju, South Korea, HHI-EMD has expanded its presence as an EPC contractor into the global power industry and completed quality diesel power plants around the world.

HHI-EMD successfully completed a 60MW diesel power plant in Israel, a 50MW and a 36MW diesel power plant in Malaysia, a 200MW diesel power plant in India (the largest diesel power plant in the world using a diesel engine as its prime mover), two 30MW diesel power plants in Mauritius, and a 42MW diesel power plant in Mexico.



GMR Vasavi 200MW Diesel Power Plant, India(HYUNDAI-MAN B&W 12K90MC-S x 4)

### Range of 2-Stroke Stationary Engine

Diesel Engine		No. of Cylinders	Speed(rpm)		Output(kW)/Cylinder	
Model	Type		50Hz	60Hz	50Hz	60Hz
HYUNDAI-MAN B&W	K98MC-S	9-14	103.4	102.9	5,680	5,650
	K90MC-S	7-12	107.1	109.1	4,290	4,260
	K80MC-S	7-12	107.1	109.1	3,390	3,360
	K60MC-S	7-14	150	150	1,980	1,980
	K50MC-S	7-14	176.5	180	1,420	1,450
	L42MC-S	7-12	187.5	189.5	1,060	1,070
	L35MC-S	7-12	214.3	211.8	645	640



1 2

1. Fort George 60MW Diesel Power Plant, Mauritius (HYUNDAI-MAN B&W 9K80MC-S x 2)
2. 60MW BLPC Diesel Power Plant, Barbados (HYUNDAI-MAN B&W 9K80MC-S x 2)

## Prime Mover: 4-Stroke Engine

HHI-EMD provides a range of services for establishing an engine power plant:

- Feasibility study
- Financial resource assistance
- Operation and maintenance
- Training
- Rehabilitation
- Tool and spare parts supply
- Local presence of expert personnel



### Range of 4-Stroke Stationary Engine

Engine		Power Range
Model	Type	
HiMSEN	H21/32	1,200 - 1,800 kW
	H21C	1,200 - 2,160 kW
	H25/33	1,740 - 2,700 kW
	H25/33V	3,840 - 6,400 kW
	H32/40	2,850 - 4,275 kW
	H32/40V	5,700 - 9,500 kW
	H35/40G	2,880 - 4,320 kW
	H35/40GV	5,760 - 9,600 kW
	H27DF	1,710 - 2,790 kW
	H35DF	2,880 - 4,320 kW
	H35DFV	5,760 - 9,600 kW
	H46/60V	14,400 - 22,500 kW



3 3  
4 4



3. 300 MW Global I&II, Brazil (HiMSEN 9H25/33 x 120)
4. 148 MW Camacari, Brazil (HiMSEN 9H25/33 x 60)



# Packaged Power Station

## Prime Mover: HIMSSEN Engine

HHI-EMD has developed the Packaged Power Station using HIMSSEN engines for captive power such as those used in factories, shopping malls, hotels, rental businesses and so on.

The Packaged Power Station, a result of HHI-EMD's creative and technological prowess, will bring contentment to power customers.

Engine	6H21/32	8H21/32	9H21/32
Engine (kW)	1,200	1,600	1,800
Generator (kW)	1,128	1,504	1,701
Total Weight (ton)	42	48	50
Dimension (W x H x L)	2.4 m x 3.4 m x 12 m (Container Size)		
Cooling Method	Radiator / Cooling Tower		
Speed	900 rpm / 1,000 rpm		
Fuel	Diesel oil / Heavy fuel oil		

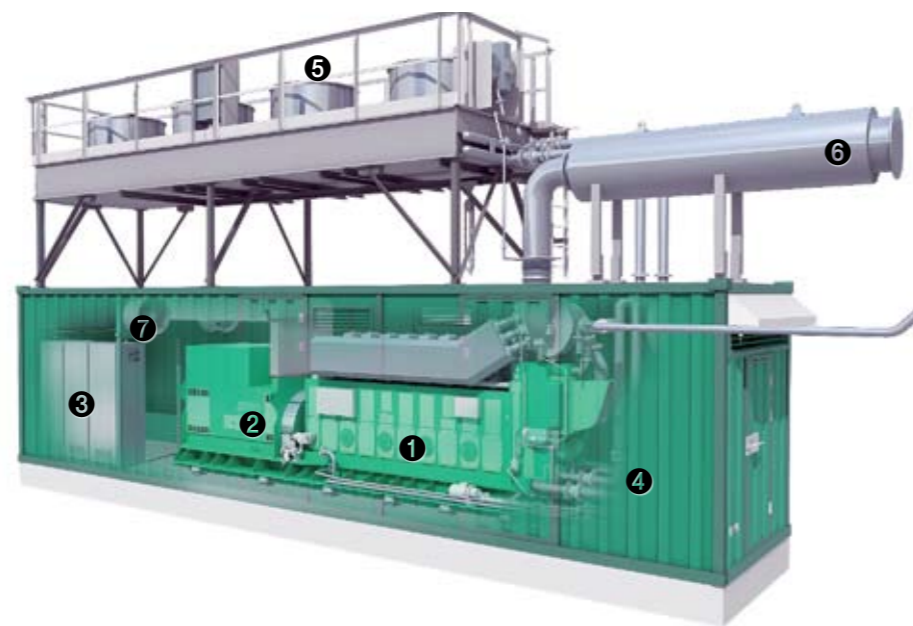

- 1 Engine
- 2 Generator
- 3 Control Panel
- 4 Enclosure
- 5 Radiator
- 6 Exhaust Gas Silencer
- 7 Ventilation Air Exhaust Fan

## Key Features & Benefits

- Base load operation
- Diesel oil / heavy fuel oil / natural gas use
- Compact 40-foot container size
- Mobile type (optional)
- Environmentally comfortable
- Low operation and maintenance cost

## Applications

- Captive power
- Construction sites
- Isolated areas
- Rental business
- Pumping stations
- Independent power producers



1. Santa-Elena 90 MW PPS in Ecuador (HYUNDAI-HIMSSEN 9H21/32 x 53 Sets)
2. Puerto-principe 34 MW PPS in Hitai (HYUNDAI-HIMSSEN 9H21/32 x 20 Sets)
3. BioBio 13.6 MW PPS in Chile (HYUNDAI-HIMSSEN 9H21/32 x 8 Sets)
4. Namibia 10 MW PPS in Namibia (HYUNDAI-HIMSSEN 9H21/32 x 6 Sets)
5. Masaya 61 MW PPS in Nicaragua (HYUNDAI-HIMSSEN 9H21/32 x 36 Sets)
6. REGLA 47.6MW Packaged Power Station in Cuba (HYUNDAI-HIMSSEN 9H21/32 x 28 Sets)
7. J-Project 5.6 MW PPS in Japan (HYUNDAI-HIMSSEN 9H21/32 x 4 Sets)

# HHI-EMD PRODUCTION CAPABILITIES

[PRODUCTION FACILITY](#)

[RESEARCH & DEVELOPMENT](#)

[CUSTOMER SERVICE](#)

[GLOBAL NETWORK](#)

[CONTACT US](#)



## Foundry Shop

### Foundry Shop

The Foundry Shop can produce 66,000 tons of castings annually. The modern melting facilities include a 24-ton and a 20-ton medium-frequency induction furnace to produce various kinds of castings.

To produce the best and reliable quality products, the Foundry Shop is equipped with computerized facilities that allow an integrated production control system ranging from raw materials to machining, assembling and testing.



1



2 3

- 1. Induction Furnace
- 2. Pouring
- 3. Shot Blast Machine

### Machining Shop

HHI-EMD's Machining Shop is equipped with over 185 sets of machine tools including up-to-date computerized and numerically controlled machines.

Our CAD/CAM system provides technical assistance so that any kind of high precision products can be made in response to various customer requirements.

#### Major Facilities

- CNC: ab. 250 Sets
- Plano Miller: 40 Sets
- Horizontal Boring M/C: 50 Sets
- Lathe: 70 Sets
- Grinding M/C: 10 Sets

## Machining Shop & Assembly-Test Shop

### Machining Shop

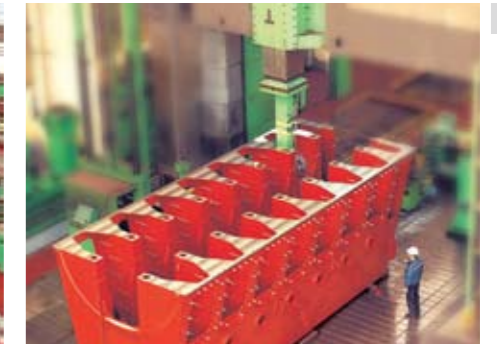

1 2

- 1. Machining Shop
- 2. Machining of Cylinder Frame
- 3. Cross Head Pin
- 4. Cylinder Cover
- 5. Cylinder Liner
- 6. Intermediate Shaft



3 4  
5 6

### Assembly & Test Shop

#### 2-stroke Engine Assembly & Test Shop

- HYUNDAI-MDT
- HYUNDAI-WinGD



#### 4-stroke Engine Assembly & Test Shop

- HYUNDAI-HIMSEN





# Quality Management

## HHI-EMD's Quality Management System

HHI-EMD has established the quality management policy to consistently provide products and services that meet regulatory requirements and our clients' needs. We will carry out this policy by:

- Minimizing the quality failure cost.
- Establishing the standardization of design and production.
- Setting up a cooperative system for quality control.

HHI-EMD complies with the Quality Management System (ISO 9001/KS A9001) in accordance with international quality standards and conducts thorough quality inspection over entire process with international classification societies and authorized inspection agencies.

### Approval Status of Quality Management System

Product or Service Ranges	Certifying Agency
Design and Manufacture of Two-stroke Diesel Engines, Four-stroke Diesel Engines, Marine Propellers, Pumps & Valves, Press, Conveyor, Robots for Industrial Purposes, Steam Turbine, Gas Turbine, Diesel Power Plants and Engine Components including Turbochargers, Crankshafts, Cylinder Liners, Forged Steel, Shafting	ISO 9001:2000, KS A 9001:2001 ISO 14001:2004, KS A 14001:2004 OHSAS 18001:1999 (DNV)
Nuclear Diesel Generator (Class 1E), Pump and Butterfly Valve	Qualification Approval (KEPIC)
Forging Shop Casting Shop Propeller Semi built-up Crankshaft Solid Crankshaft (TR Forging Crankshaft)	Works Approval (ABS, BV, CCS, DNV, GL, KR, LR, NK, RINA)
Welding Workshop & Overlay Welding on Cylinder Cover	Works Approval(GL)



# Research & Development

## Research & Development

HHI's commitment to research and development (R&D) creates advanced products and services for our clients by focusing on the development of market-driven technology. HHI-EMD is technologically supported from HHI's Corporate Research Center and other business research institutes to answer owners' specific needs in the market.

### HHI's R&D Organization comprises of:

#### Corporate Research Center

- Advanced Technology Research Institute
- Energy System Research Institute
- Convergence Technology Research Institute

#### Business Division Research Institutes

- Maritime Research Institute (HMRI)
- Engine Research Institute
- Electro-Electric Systems Research Institute
- Construction Equipment Research Institute
- Green Energy Research Institute
- Robotics Research Institute

#### HMRI (Hyundai Maritime Research Institute)

- Ship Powering/Navigation Performance
- Optimum Hull Form Development & Propulsion
- Seakeeping & Maneuvering
- Ship & Offshore Hydrodynamics
- New Types of LNG Cargo Containment Systems

#### Engine Research Institute

- Engine Performance
- Product Reliability
- Cooling and Lubricating System
- CHP System
- Intelligent Control & Diagnostic System

#### Advanced Technology Research Institute

- Development of Welding Process and Equipment
- Material Process Design and Corrosion Management
- Design and Analysis for Steel/Concrete Structures
- Computer-Aided Design for Manufacturing Process
- Development of Coating/Automatic Painting Systems





## Hyundai Global Service

### Hyundai Global Service Co.,Ltd

#### Total Solution Provider, One Stop Service

HHI is set to embark on a new journey by setting up an integrated A/S unit to fulfill after-sales needs for shipbuilding, engine and marine electric products.

The new entity named "Hyundai Global Service Co.,Ltd" is launched in Dec. 2016.

Hyundai Global Service will not only provide marine parts to keep your vessels up and running, but also offer technical support to maintain and improve the vessel performance based on accumulated data.

Moreover, the company seeks to establish a prompt A/S system and deliver eco-friendly services by harnessing state-of-the-art ICT, to encourage our clients to come back for repurchase. In particular, Hyundai Global Service will leverage on the proprietary supply chain of its parent company so it can provide one-stop services and total solutions.

By launching the new entity, the right of service business including global service network of Hyundai Heavy Industries Co.,Ltd (HHI) is authorized to Hyundai Global Service Co.,Ltd (HGS)

#### Anywhere, Anytime, for Any Matters

Hyundai Global Service can identify, monitor, track and solve your technical problems through its integrated services and supports.

#### Easy Access to Service

Hyundai Global Service helps clients extend the life of their ships during or even after the warranty period. Our one-stop service center ensures that your Hyundai ships and engines are repaired and upgraded to meet industry standards throughout its entire lifespan.

#### Genuine Spare Parts Service

Hyundai Global Service provides a rapid and reliable supply of spare parts at a competitive price throughout the lifespan of your ships. Just contact Hyundai Global Service to find right parts in time for your ships.

#### Technical Support Service

Hyundai Global Service provides quick and effective technical assistance and technical consultancy for ships and all ranges of engines. With over 40 years of experience in shipbuilding industry, we know every corner of your ship and provide technical support tailored to your needs.

#### Global Service Network

Hyundai Global Service is networked with service bases in Rotterdam, Dubai, Singapore, Houston and Athens, delivering prompt solutions and comprehensive services for the benefit of our clients around the world.



## HiMSEN Global Academy

HiMSEN Global Academy of Hyundai Global Service offers tailored programs that train HiMSEN engine operators and maintenance staff to support safe operation in ships and power plants.

We run learning courses and hands-on training programs about functions of main components, engine operation and maintenance, electrical systems and control systems.

We promise that you will learn everything about our HiMSEN engines when you complete courses of HiMSEN Global Academy. For more information, please contact Hyundai Global Service through our email "service@hyundai-gs.com" or "sales@hyundai-gs.com".



# Global Network

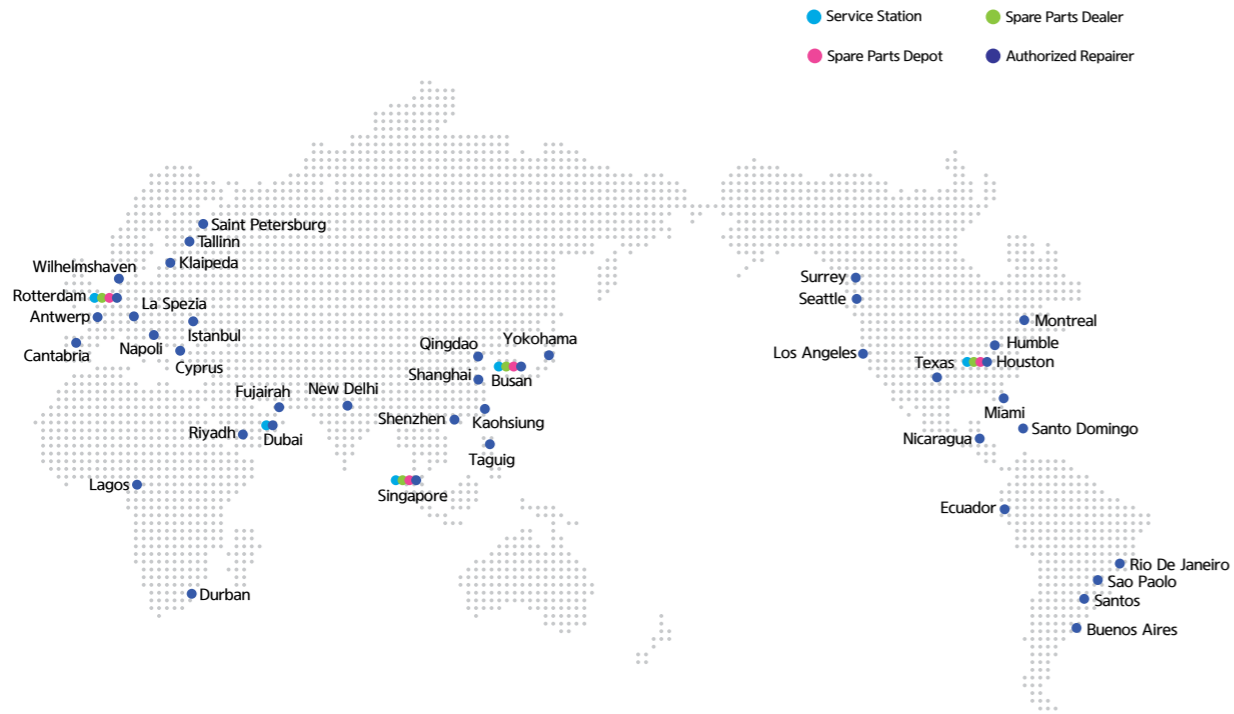

# Contact Us

## Marine Engine & Machinery

Marine Engine & Machinery Sales Department  
 1000, Bangeojinsunhwan-doro, Dong-gu, Ulsan, Korea (Zip Code: 44032)  
 Tel: +82.52.202.7281/7291 | E-mail: eningesales@hhi.co.kr

## HiMSEN Propulsion System

HiMSEN Propulsion System Department  
 1000, Bangeojinsunhwan-doro, Dong-gu, Ulsan, Korea (Zip Code : 44032)  
 Tel : +82.52.202.7293  
 E-mail : k110@hhi.co.kr

## Power Plant

Engine Power Plant Sales Department  
 1000, Bangeojinsunhwan-doro, Dong-gu, Ulsan, Korea (Zip Code: 44032)  
 Tel: +82.52.202.7301~10  
 E-mail: k120hhi@hhi.co.kr

## Customer Service

Hyundai Global Service Co. Ltd  
 Centum Science Park 6F 79, Centum jungang-ro, Haeundae-gu, Busan, Korea (Zip code : 48058)

**Warranty Service**  
 Tel: +82.52.204.7760 (2-stroke Marine)  
 +82.52.204.7887 (4-stroke Marine)  
 +82.52.204.7742 (Stationary)  
 Fax: +82.52.204.7801  
 E-Mail: service@hyundai-gs.com

**Parts Sales**  
 Tel: +82.52.204.7718 (2-stroke and 4-stroke Marine)  
 +82.52.204.7742 (Stationary)  
 Fax: +82.52.204.7700  
 E-Mail: sales@hyundai-gs.com



**Global Leader**

[www.hhi.co.kr](http://www.hhi.co.kr)

Copyright © 2018 Hyundai Heavy Industries

June 2018. Contents subject to change without prior notice.

**HYUNDAI**   
**HiMSEN**